



*The Pumps with Nine Lives*

# PUMP CATALOG



# CAT PUMPS

*The Pumps with Nine Lives*

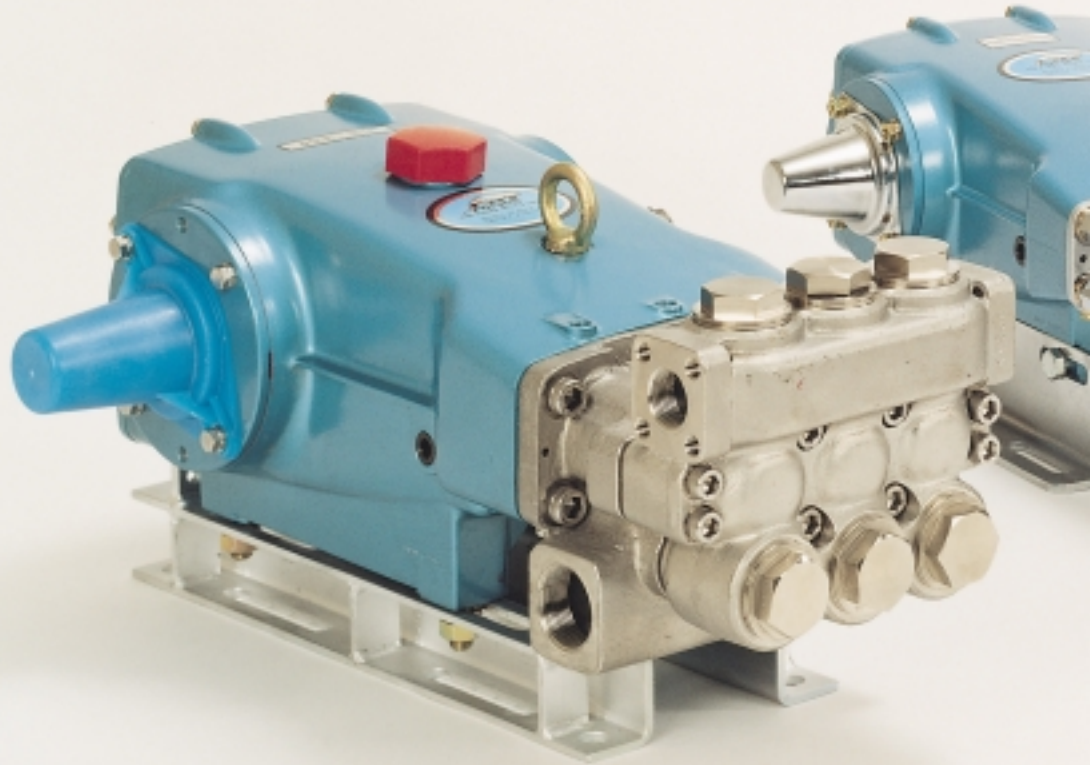

## *Quality defines CAT PUMPS*

CAT PUMPS are triplex, positive displacement, reciprocating, high pressure pumps; the most cost-effective pump design for achieving high-efficiency and low pulsation.

Constructed of the highest quality materials, manufactured under close tolerance control and fully tested before leaving the factory, no other pump offers such consistent high standards of quality and dependability.



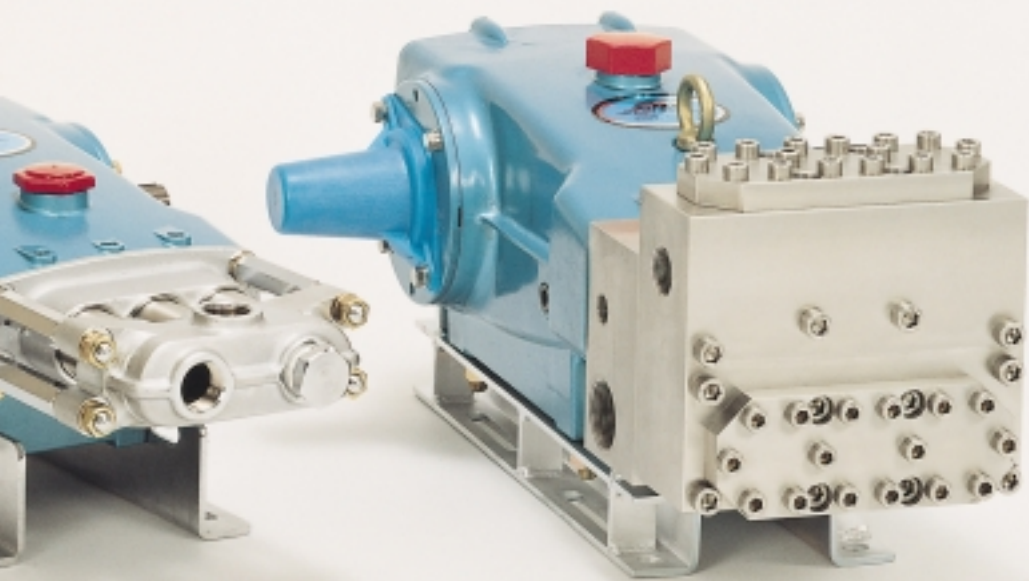

## Index

General Information	4-5
3 and 5 Frame Plunger Pumps	6
3, 5 and 7 CP Frame Plunger Pumps	7
7 and 15 Frame Plunger Pumps	8
25, 35 and 60 Frame Plunger Pumps	9
8, 18, 28, 38 and 68 Frame SSL Block-Style Plunger Pumps	10
150 Frame R-Series Plunger Pumps	11
DX and SP Direct-Drive Plunger Pumps	12
SF Direct-Drive Plunger Pumps	13
3, 4, 5, and 10 Frame Piston Pumps	14
25 and 60 Frame Piston Pumps	15
Specialized Pumps and Motorized Units	16
Power Units	17
K-Series Centrifugal Pumps	18
Accessories	19



# Proven Design and Quality Components Assure Long-Term Performance

Triplex  
Plunger  
Pumps

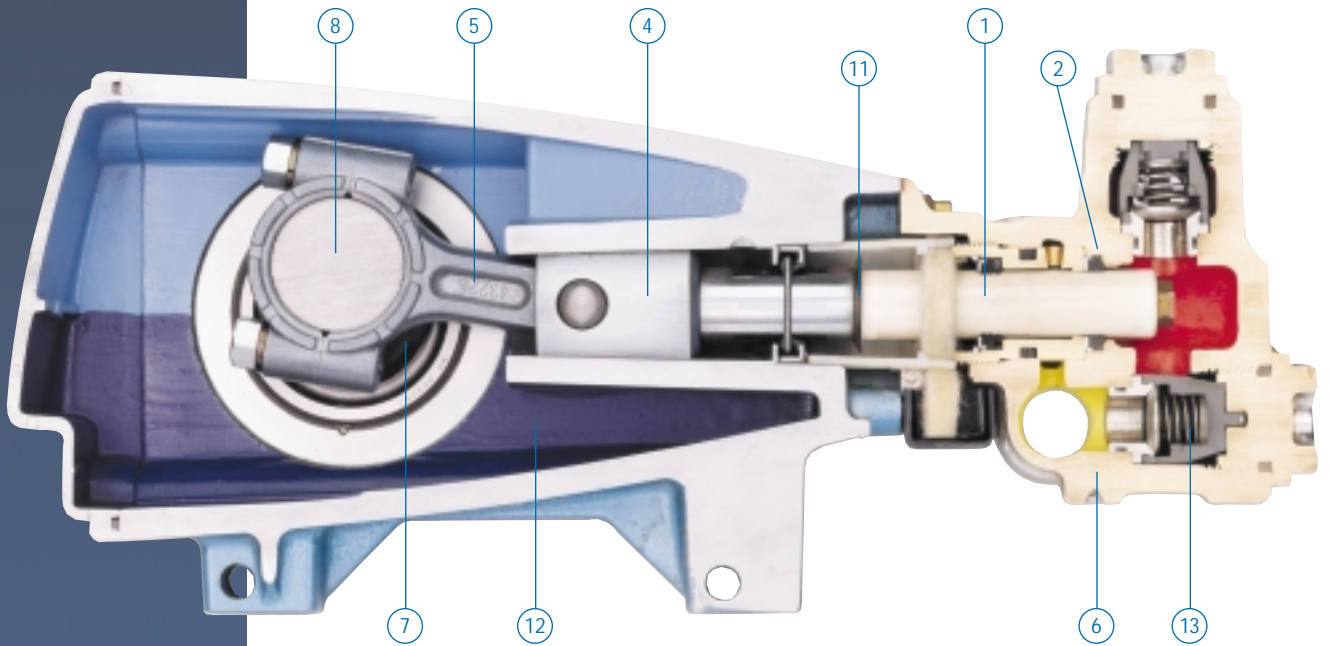

1. Special concentric, high-density, polished, solid **ceramic plungers** are resistant to abrasion and result in extended seal life.
2. Specially formulated, CAT PUMP exclusive Hi-Pressure **Seal** offers unmatched performance and seal life. Optional FPM, EPDM, PTFE or other special materials for application compatibility.
3. 100% wet **cup/seal** design adds to service life by allowing pumped liquids to cool and lubricate the elastomers on both sides.
4. The high strength stainless steel **plunger rods** have a 360° supported crosshead providing uncompromising plunger rod alignment.
5. Matched oversized **connecting rods** are made of high strength alloys with exceptional bearing quality.
6. High strength forged brass **manifolds**. Optional 316 stainless steel, nickel aluminum bronze or Duplex SS for exceptional corrosion resistance.
7. Oversized ball **bearings** or tapered roller bearings provide extended bearing life.
8. Chrome-moly **crankshaft** provides unmatched strength and surface hardness for long life.
9. The patented stepped **piston rod** with hard chrome-plated sleeve provides a durable wear surface and easy wet-end servicing.
10. The **cylinder** and **sleeve** wear surfaces are hard chrome-plated stainless steel for longer service life.
11. The stainless steel **slinger** provides back-up protection for the crankcase oil seal, keeping pumped liquids out of the crankcase.
12. Die cast aluminum **crankcase** offers high strength, light weight, and excellent tolerance control. Optional cast iron.
13. Spherical **Quiet Valves** offer self-centering and positive seating. Stainless Steel valves, seats and springs provide corrosion resistance and extended service life.



## Triplex Piston Pumps

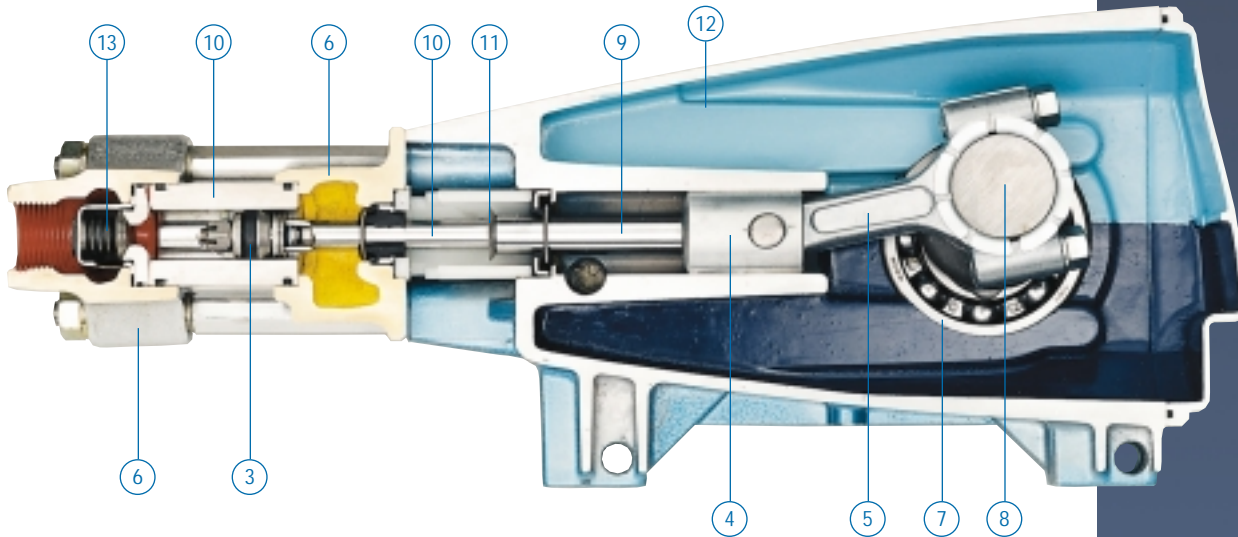

## Selecting a CAT PUMP

The following steps will simplify the selection of a CAT PUMP. CAT PUMPS are triplex reciprocating plunger or piston pumps. They deliver a specified amount of flow determined by the bore, stroke and RPM of the pump.

- ▶ **Frame Sizes** As the frame size increases, the bore and stroke increase, resulting in higher flow capacity through the CAT PUMP and higher horsepower.
- ▶ **Plunger Pumps** Abrasion resistant ceramic plungers reciprocate through static high and low pressure seals. CAT PUMPS plunger pumps handle high pressures, are resistant to abrasion and have a variety of drive options meeting many demanding requirements.
- ▶ **Piston Pumps** Dynamic piston assemblies, Uniflow valve design and mechanically actuated inlet valves result in strong suction capabilities.
- ▶ **Manifold Material** Select a manifold material to match the liquid requirements. CAT PUMPS have a variety of materials to handle your requirements: Brass (BB), 304 Stainless Steel (S), 316 Stainless Steel (SS), 316 Stainless Steel Low Carbon (SSL) or Nickel Aluminum Bronze (NAB). For hi-temp or effluent liquids select the block-style or special flushed version (SSL Flushed). See our Chemical Compatibility Guide under Service on the CAT PUMPS web site to aid in selecting your manifold material.
- ▶ **Drive Type** CAT PUMPS are known for their drive-end durability and dependability, we offer a variety of drive types to meet your requirements. Belt driven, clutch, direct-drive for gas engines or electric motors, and gearbox drives are available to meet your requirements.

## Click and Find

[www.catpumps.com](http://www.catpumps.com)

The quickest way to find a CAT PUMP is with a mouse. Our web site is easy to navigate and quick to satisfy your pump needs. If you are new to CAT PUMPS and not sure which model is right for you, visit our web site Product Selector. Click on "Select A Pump", then enter your flow, pressure, drive-type, and material of construction. Several pump options will be provided. You will then be able to view each of these pump data sheets and add your selection to a shopping list to request a quote.



**CAT PUMPS**  
The Pumps with Nine Lives  
[www.catpumps.com](http://www.catpumps.com)

# Ultra-Dependable Mid-Size Industrial Pumps

Legendary  
Reliability

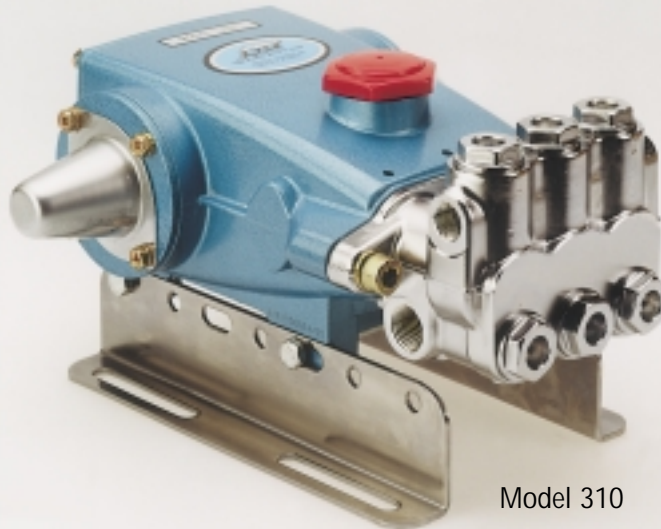

Model 310



270



Stainless Steel

311



45G1

## 3 AND 5 FRAME TRIPLEX PLUNGER PUMP SELECTION

PUMP MODEL	Flow GPM (L/M)	Pressure PSI (BAR)	Manifold Material	Horsepower HP (kW)	RPM	Drive Type
<b>3 Frame</b> + Alternate performance rating.						
230	2.3 (8.7)	100 to 1500 (7 to 105)	Brass	2.4 (1.8)	1725	Belt/Direct
231	2.3 (8.7)	100 to 1500 (7 to 105)	SS	2.4 (1.8)	1725	Belt/Direct
237	2.3 (8.7)	100 to 1500 (7 to 105)	NAB	2.4 (1.8)	1725	Belt/Direct
240	3.6 (13.6)	100 to 1200 (7 to 85)	Brass	3.0 (2.2)	1725	Belt/Direct
241	3.6 (13.6)	100 to 1200 (7 to 85)	SS	3.0 (2.2)	1725	Belt/Direct
247	3.6 (13.6)	100 to 1200 (7 to 85)	NAB	3.0 (2.2)	1725	Belt/Direct
270	3.5 (13.2)	100 to 1500 (7 to 105)	Brass	3.6 (2.7)	1420	Belt
270 +	4.2 (15.9)	100 to 1000 (7 to 70)	Brass	2.9 (2.1)	1725	Belt/Direct
271	3.5 (13.2)	100 to 1500 (7 to 105)	SS	3.6 (2.7)	1420	Belt
277	3.5 (13.2)	100 to 1500 (7 to 105)	NAB	3.6 (2.7)	1420	Belt
<b>5 Frame</b>						
310	4.0 (15.0)	100 to 2200 (7 to 155)	Brass	6.0 (4.5)	950	Belt
311	4.0 (15.0)	100 to 2200 (7 to 155)	SS	6.0 (4.5)	950	Belt
317	4.0 (15.0)	100 to 2200 (7 to 155)	NAB	6.0 (4.5)	950	Belt
340	4.0 (15.0)	100 to 1800 (7 to 125)	Brass	5.0 (3.7)	1725	Belt/Direct
340C1	4.0 (15.0)	100 to 1800 (7 to 125)	Brass	5.0 (3.7)	1725	Clutch-12 VDC
341	4.0 (15.0)	100 to 1800 (7 to 125)	SS	5.0 (3.7)	1725	Belt/Direct
347	4.0 (15.0)	100 to 1800 (7 to 125)	NAB	5.0 (3.7)	1725	Belt/Direct
350	5.0 (19.0)	100 to 1500 (7 to 105)	Brass	5.1 (3.8)	1725	Belt/Direct
351	5.0 (19.0)	100 to 1500 (7 to 105)	SS	5.1 (3.8)	1725	Belt/Direct
357	5.0 (19.0)	100 to 1500 (7 to 105)	NAB	5.1 (3.8)	1725	Belt/Direct
<b>5 Frame - Single Shaft</b>						
31	4.0 (15.0)	100 to 2200 (7 to 155)	Brass	6.0 (4.5)	950	Belt
34	4.0 (15.0)	100 to 1800 (7 to 125)	Brass	5.0 (3.7)	1725	Belt/Direct
34G1	4.0 (15.0)	100 to 2000 (7 to 140)	Brass	5.5 (4.1)	3515	Gearbox
35	5.0 (19.0)	100 to 1500 (7 to 105)	Brass	5.1 (3.8)	1725	Belt/Direct
35G1, 35G118	5.0 (19.0)	100 to 1500 (7 to 105)	Brass	5.1 (3.8)	3515	Gearbox
45	4.5 (17.0)	100 to 3500 (7 to 245)	Brass	10.8 (8.0)	1645	Belt
45G1, 45G118	4.5 (17.0)	100 to 3500 (7 to 245)	Brass	10.8 (8.0)	3515	Gearbox

Detailed Data Sheets are available for each model at [www.catpumps.com/data sheets](http://www.catpumps.com/data sheets).



# High Pressure Mid-Size Industrial Pumps

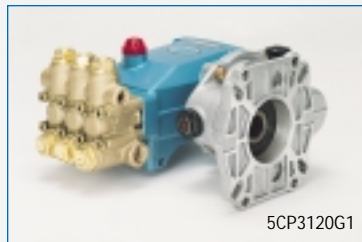

*Durable,  
Easy to  
Service  
Manifolds*

## 3, 5 AND 7 CP FRAME TRIPLEX PLUNGER PUMP SELECTION

PUMP MODEL	Flow GPM (L/M)	Pressure PSI (BAR)	Manifold Material	Horsepower HP (kW)	RPM	Drive Type
<b>3CP</b>						
3CP1120	4.2 (16.0)	100 to 2200 (7 to 155)	Brass	6.3 (4.7)	1725	Belt/Direct
3CP1120C1	4.2 (16.0)	100 to 2200 (7 to 155)	Brass	6.3 (4.7)	1725	Clutch-12 VDC
3CP1120G	3.5 (13.2)	100 to 2200 (7 to 155)	Brass	5.3 (3.9)	3600	Gearbox
3CP1130	2.4 (9.0)	100 to 2200 (7 to 155)	Brass	3.6 (2.7)	1725	Belt/Direct
3CP1140	3.6 (13.6)	100 to 2200 (7 to 155)	Brass	5.4 (4.0)	1725	Belt/Direct
<b>5CP</b>						
5CP2120W	4.0 (15.0)	100 to 2500 (7 to 175)	W770	6.9 (5.1)	950	Belt
5CP2140WCS	4.0 (15.0)	100 to 2500 (7 to 175)	W770	6.9 (5.1)	1725	Belt/Direct
5CP2150W	5.0 (19.0)	100 to 2000 (7 to 140)	W770	6.9 (5.1)	1725	Belt/Direct
5CP2150WC1	5.0 (19.0)	100 to 2000 (7 to 140)	W770	6.9 (5.1)	1725	Clutch-12 VDC
5CP3120	4.5 (17.0)	100 to 3500 (7 to 245)	Brass	10.8 (8.0)	1645	Belt
5CP3120G1	4.5 (17.0)	100 to 3500 (7 to 245)	Brass	10.8 (8.0)	3353	Gearbox
5CP3120CSC2	4.5 (17.0)	100 to 3500 (7 to 245)	Brass	10.8 (8.0)	2645	Clutch-12 VDC
5CP3130G1	3.8 (14.3)	100 to 3500 (7 to 245)	Brass	9.1 (6.8)	3200	Gearbox
5CP5120	5.0 (19.0)	100 to 3000 (7 to 210)	Brass	10.3 (7.7)	1415	Belt
5CP5150G1	5.0 (19.0)	100 to 3000 (7 to 210)	Brass	10.3 (7.7)	3200	Gearbox
5CP6120	6.0 (23.0)	100 to 1600 (7 to 110)	Brass	6.6 (4.9)	1400	Belt
5CP6120G1	6.7 (25.0)	100 to 1600 (7 to 110)	Brass	7.3 (5.4)	3200	Gearbox
5CP6221	6.0 (23.0)	100 to 2000 (7 to 140)	SS	8.2 (6.1)	1400	Belt
5CP6241CS	4.0 (15.0)	100 to 2000 (7 to 140)	SS	5.5 (4.1)	1725	Belt/Direct
5CP6251	5.0 (19.0)	100 to 2000 (7 to 140)	SS	6.8 (5.0)	1725	Belt/Direct
<b>7CP</b>						
7CP6170	11.0 (41.6)	100 to 2000 (7 to 140)	Brass	15.1 (11.3)	1450	Belt

Detailed Data Sheets are available for each model at [www.catpumps.com/data sheets](http://www.catpumps.com/data sheets).



**CAT PUMPS**  
The Pumps with Nine Lives  
[www.catpumps.com](http://www.catpumps.com)

# High Pressure Intermediate Industrial Pumps

Reliable High  
Pressure and  
High Flow

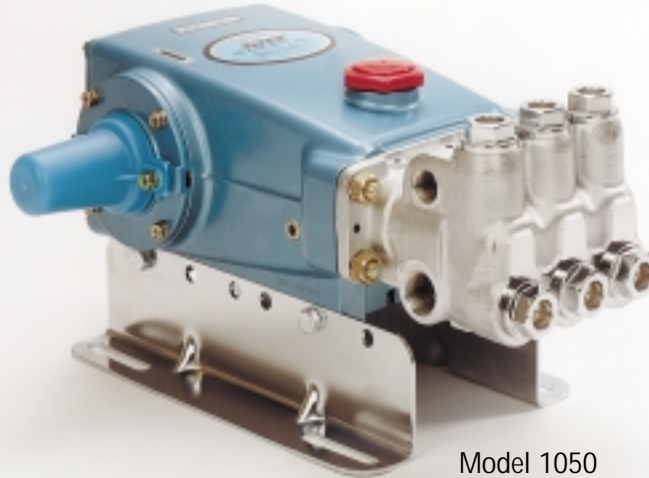

Model 1050



530



56G1



1540

## 7 AND 15 FRAME TRIPLEX PLUNGER PUMP SELECTION

PUMP MODEL	Flow GPM (L/M)	Pressure PSI (BAR)	Manifold Material	Horsepower HP (kW)	RPM	Drive Type
<b>7 Frame</b>						
530	5.0 (19.0)	100 to 2500 (7 to 175)	Brass	8.6 (6.4)	1100	Belt
550	5.0 (19.0)	100 to 3000 (7 to 210)	Brass	10.3 (7.7)	1415	Belt
<b>7 Frame - Single Shaft</b>						
51G1, 51G118	4.8 (18.0)	100 to 3000 (7 to 210)	Brass	9.8 (7.3)	3600	Gearbox
53	5.0 (19.0)	100 to 2500 (7 to 175)	Brass	8.6 (6.4)	1100	Belt
55	5.0 (19.0)	100 to 3000 (7 to 210)	Brass	10.3 (7.7)	1415	Belt
56	5.5 (21.0)	100 to 3500 (7 to 245)	Brass	13.2 (9.8)	1210	Belt
56G1, 56G118	8.0 (30.0)	100 to 1800 (7 to 125)	Brass	9.9 (7.4)	3600	Gearbox
57	4.5 (17.0)	100 to 4000 (7 to 275)	Brass	12.3 (9.2)	1285	Belt
58G1, 58G118	5.0 (19.0)	100 to 2500 (7 to 175)	Brass	8.6 (6.4)	3200	Gearbox
59G1, 59G118	5.5 (21.0)	100 to 3500 (7 to 245)	Brass	13.2 (9.8)	3200	Gearbox
60G1, 60G118	4.5 (17.0)	100 to 4000 (7 to 275)	Brass	12.3 (9.2)	3200	Gearbox
70	4.5 (17.0)	100 to 5000 (7 to 345)	Brass	15.4 (11.5)	1700	Belt
70G1, 70G118	4.5 (17.0)	100 to 5000 (7 to 345)	Brass	15.4 (11.5)	3465	Gearbox
<b>15 Frame + Alternate performance rating</b>						
650	7.0 (27.0)	100 to 3000 (7 to 210)	NAB	14.4 (10.7)	1000	Belt
660	10.0 (38.0)	100 to 3000 (7 to 210)	NAB	20.6 (15.4)	1429	Belt
661	10.0 (38.0)	100 to 3000 (7 to 210)	SSD	20.6 (15.4)	1429	Belt
1050	10.0 (38.0)	100 to 2200 (7 to 155)	Brass	15.1 (11.3)	958	Belt
1050 +	12.0 (45.0)	100 to 1800 (7 to 125)	Brass	14.8 (11.0)	1150	Belt
1051	10.0 (38.0)	100 to 2200 (7 to 155)	SS	15.1 (11.3)	958	Belt
1051 +	12.0 (45.0)	100 to 1800 (7 to 125)	SS	14.8 (11.0)	1150	Belt
1057	10.0 (38.0)	100 to 2200 (7 to 155)	NAB	15.1 (11.3)	958	Belt
1057 +	12.0 (45.0)	100 to 1800 (7 to 125)	NAB	14.8 (11.0)	1150	Belt
1530	15.6 (59.0)	100 to 1500 (7 to 105)	Brass	16.0 (11.9)	1450	Belt
1531	15.6 (59.0)	100 to 1500 (7 to 105)	SS	16.0 (11.9)	1450	Belt
1540	18.0 (68.0)	100 to 1200 (7 to 85)	Brass	14.8 (11.0)	1100	Belt

Detailed Data Sheets are available for each model at [www.catpumps.com/data sheets](http://www.catpumps.com/data sheets).





# Large Frame High Flow Industrial Pumps

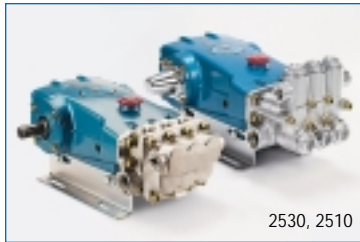

2530, 2510



3560



Stainless Steel

6761



Model 3535

*Superior  
Design  
Precision  
Components  
Exceptional  
Life*

## 25, 35 AND 60 FRAME TRIPLEX PLUNGER PUMP SELECTION

PUMP MODEL	Flow GPM (L/M)	Pressure PSI (BAR)	Manifold Material	Horsepower HP (kW)	RPM	Drive Type
<b>25 Frame</b> + Alternate performance rating						
2510	20.0 (76.0)	100 to 2000 (7 to 140)	Brass	27.5 (20.5)	1450	Belt
2511	20.0 (76.0)	100 to 1500 (7 to 105)	SS	20.6 (15.4)	1450	Belt
2530	25.0 (95.0)	100 to 1000 (7 to 70)	Brass	17.1 (12.8)	1025	Belt
2530 +	21.0 (80.0)	100 to 1200 (7 to 85)	Brass	17.3 (12.9)	860	Belt
2531	25.0 (95.0)	100 to 1000 (7 to 70)	SS	17.1 (12.8)	1025	Belt
2531 +	21.0 (80.0)	100 to 1200 (7 to 85)	SS	17.3 (12.9)	860	Belt
2537	21.0 (80.0)	100 to 1200 (7 to 85)	NAB	17.3 (12.9)	860	Belt
<b>35 Frame</b> + Alternate performance rating						
3507	9.0 (34.0)	100 to 5000 (7 to 345)	NAB	30.8 (23.0)	800	Belt
3517	14.0 (53.0)	100 to 3000 (7 to 210)	NAB	28.8 (21.5)	800	Belt
3520	23.0 (87.0)	100 to 2000 (7 to 140)	Brass	31.6 (23.6)	800	Belt
3521	23.0 (87.0)	100 to 2000 (7 to 140)	SS	31.6 (23.6)	800	Belt
3527	23.0 (87.0)	100 to 2000 (7 to 140)	NAB	31.6 (23.6)	800	Belt
3531	36.0 (136.0)	100 to 1200 (7 to 85)	SS	29.7 (22.1)	800	Belt
3535	36.0 (136.0)	100 to 1200 (7 to 85)	Brass	29.7 (22.1)	800	Belt
3537	36.0 (136.0)	100 to 1200 (7 to 85)	NAB	29.7 (22.1)	800	Belt
3541	45.0 (170.0)	100 to 1000 (7 to 70)	SS	30.9 (23.1)	765	Belt
3545	45.0 (170.0)	100 to 1000 (7 to 70)	Brass	30.9 (23.1)	765	Belt
3560	20.0 (76.0)	100 to 4000 (7 to 275)	Brass/SS	54.8 (40.9)	1160	Belt
3560 +	25.0 (95.0)	100 to 3000 (7 to 210)	Brass/SS	51.4 (38.3)	1450	Belt
<b>60 Frame</b> + Alternate performance rating						
6747	48.0 (182.0)	100 to 2000 (7 to 140)	NAB	65.8 (49.1)	615	Belt
6760	75.0 (284.0)	100 to 1000 (7 to 70)	Brass	51.4 (38.3)	643	Belt
6761	60.0 (227.0)	100 to 1200 (7 to 85)	SS	49.4 (36.8)	520	Belt
6761 +	70.0 (265.0)	100 to 1000 (7 to 70)	SS	48.0 (35.8)	600	Belt
6767	60.0 (227.0)	100 to 1200 (7 to 85)	NAB	49.4 (36.8)	520	Belt
6767 +	70.0 (265.0)	100 to 1000 (7 to 70)	NAB	48.0 (35.8)	600	Belt

Detailed Data Sheets are available for each model at [www.catpumps.com/data sheets](http://www.catpumps.com/data sheets).



# 316 SS Industrial Block-Style Pumps

*Stainless  
Steel  
Manifolds  
for Excellent  
Corrosion  
Resistance*

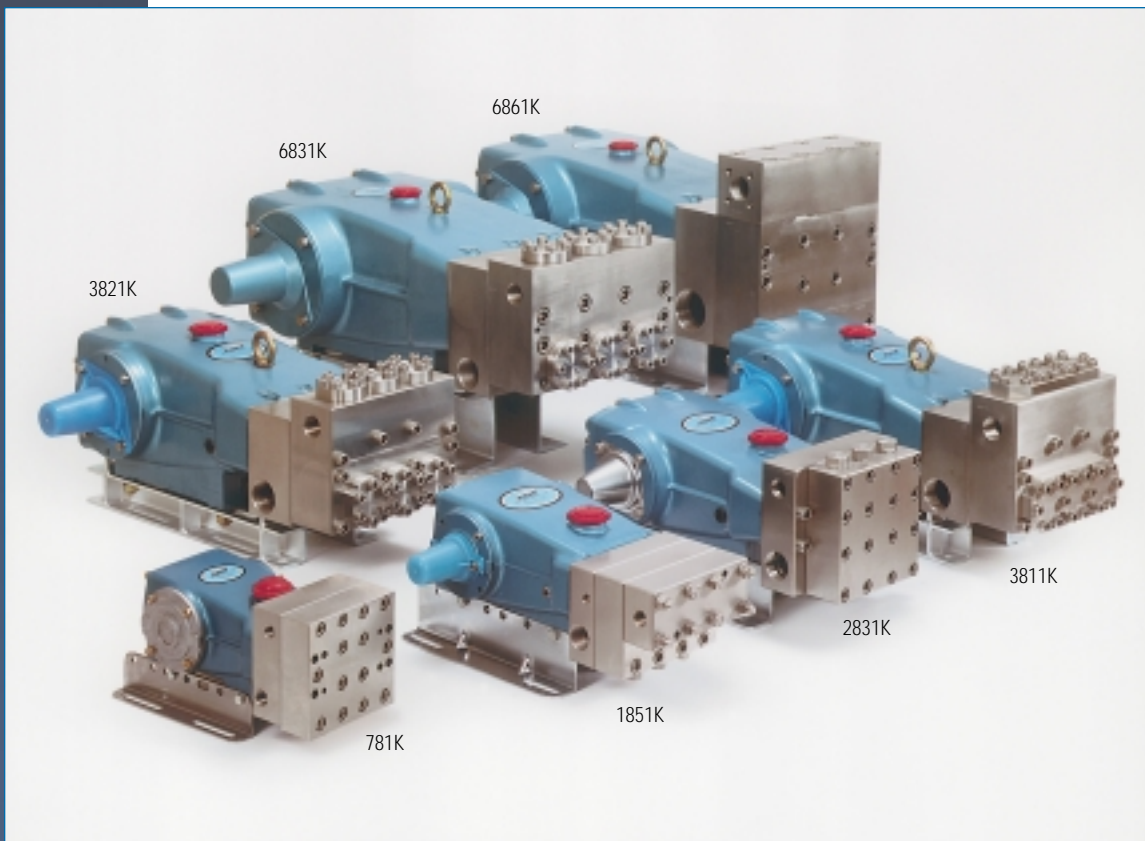

## 8, 18, 28, 38 AND 68 FRAME BLOCK-STYLE TRIPLEX PLUNGER PUMP SELECTION

PUMP MODEL	Flow GPM (L/M)	Pressure PSI (BAR)	Manifold Material	Horsepower HP (kW)	RPM	Drive Type
<b>8 Frame</b>						
781 / 781K	4.5 (17.0)	100 to 5000 (7 to 345)	SSL / SSL Flushed	15.4 (11.5)	1700	Belt
<b>18 Frame</b>						
1851 / 1851K	10.0 (38.0)	100 to 2200 (7 to 155)	SSL / SSL Flushed	15.1 (11.3)	958	Belt
1861 / 1861K	10.0 (38.0)	100 to 3000 (7 to 210)	SSL / SSL Flushed	20.6 (15.4)	1429	Belt
<b>28 Frame</b> + Alternate performance rating.						
2831 / 2831K	25.0 (95.0)	100 to 1000 (7 to 70)	SSL / SSL Flushed	17.1 (12.8)	1025	Belt
2831 / 2831K +	21.0 (80.0)	100 to 1200 (7 to 85)	SSL / SSL Flushed	17.3 (12.9)	860	Belt
<b>38 Frame</b>						
3801 / 3801K	9.0 (34.0)	100 to 5000 (7 to 345)	SSL / SSL Flushed	30.8 (23.0)	800	Belt
3811 / 3811K	14.0 (53.0)	100 to 3000 (7 to 210)	SSL / SSL Flushed	28.8 (21.5)	800	Belt
3821 / 3821K	23.0 (87.0)	100 to 2000 (7 to 140)	SSL / SSL Flushed	31.6 (23.6)	800	Belt
3831 / 3831K	36.0 (136.0)	100 to 1200 (7 to 85)	SSL / SSL Flushed	29.7 (22.1)	800	Belt
3841 / 3841K	45.0 (170.0)	100 to 1000 (7 to 70)	SSL / SSL Flushed	30.9 (23.1)	765	Belt
<b>68 Frame</b> + Alternate performance rating.						
6811 / 6811K	15.0 (57.0)	100 to 5000 (7 to 345)	SSL / SSL Flushed	51.5 (38.4)	600	Belt
6811 / 6811K +	15.0 (57.0)	100 to 7000 (7 to 485)	SSL / SSL Flushed	72.0 (53.7)	600	Belt
6821 / 6821K	25.0 (95.0)	100 to 3000 (7 to 210)	SSL / SSL Flushed	51.4 (38.3)	615	Belt
6831 / 6831K	40.0 (151.0)	100 to 2300 (7 to 160)	SSL / SSL Flushed	63.0 (47.0)	625	Belt
6841 / 6841K	48.0 (182.0)	100 to 2000 (7 to 140)	SSL / SSL Flushed	65.8 (49.1)	615	Belt
6861 / 6861K	60.0 (227.0)	100 to 1200 (7 to 85)	SSL / SSL Flushed	49.3 (36.8)	520	Belt
6861 / 6861K +	70.0 (265.0)	100 to 1000 (7 to 70)	SSL / SSL Flushed	48.0 (35.8)	600	Belt

Detailed Data Sheets are available for each model at [www.catpumps.com/data sheets](http://www.catpumps.com/data sheets).



# Heavy-Duty Duplex SS Process Pumps

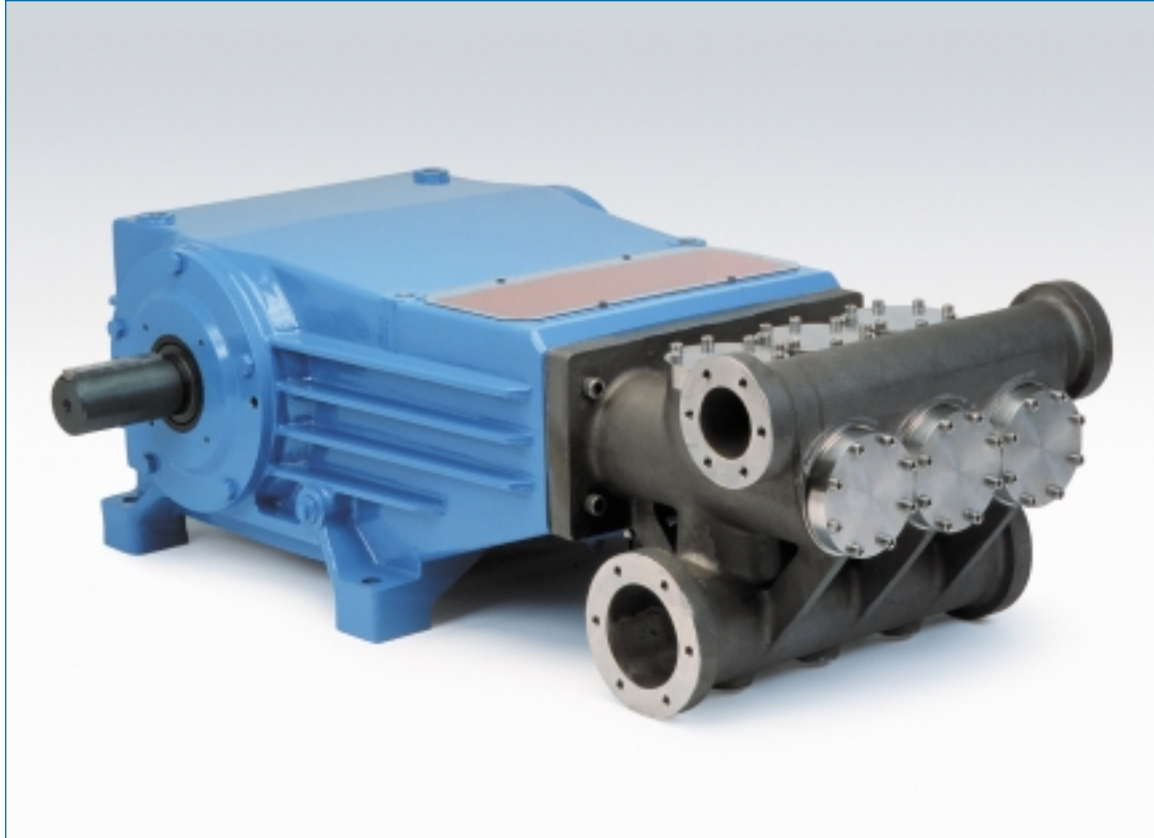

*Duplex  
Stainless Steel  
Liquid End  
No Adjustment  
Packings*

## 150 FRAME R-SERIES TRIPLEX PLUNGER PUMP SELECTION

PUMP MODEL	Flow GPM (L/M)	Pressure PSI (BAR)	Manifold Material	Horsepower HP (kW)	RPM	Drive Type
<b>150 Frame</b> + Alternate performance rating.						
152R060	115.0 (435.0)	100 to 1200 (7 to 85)	Duplex Stainless	94.5 (70.5)	360	Belt
152R080	200.0 (757.0)	100 to 1200 (7 to 85)	Duplex Stainless	164.4 (122.6)	355	Belt
152R100	260.0 (984.0)	100 to 1000 (7 to 70)	Duplex Stainless	178.1 (132.8)	295	Belt
152R100 +	320.0 (1211.0)	100 to 825 (7 to 57)	Duplex Stainless	181.0 (134.8)	360	Belt
157R060	100.0 (379.0)	100 to 2700 (7 to 190)	Duplex Stainless	184.9 (137.9)	310	Belt

Detailed Data Sheets are available for each model at [www.catpumps.com/data sheets](http://www.catpumps.com/data sheets).



**CAT PUMPS**  
The Pumps with Nine Lives  
[www.catpumps.com](http://www.catpumps.com)

# Compact High Pressure Direct-Drive Pumps

Dependable  
Gas Engine  
Direct-Drive

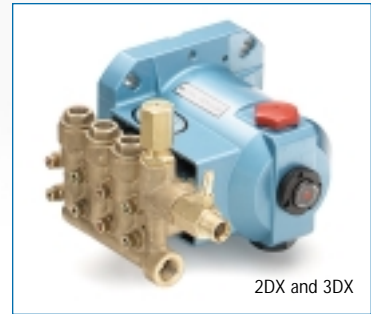

## DX AND SP DIRECT-DRIVE TRIPLEX PLUNGER PUMP SELECTION

PUMP MODEL	Flow GPM (L/M)	Pressure PSI (BAR)	Manifold Material	Horsepower HP (kW)	RPM	Drive Type
<b>2DX</b>						
2DX20ES	2.0 (7.6)	100 to 2000 (7 to 140)	Brass	2.7 (2.0)	3450	Direct, Electric
2DX27GS	2.7 (10.2)	100 to 2000 (7 to 140)	Brass	3.7 (2.8)	3450	Direct, Gas
2DX30GS	3.1 (11.7)	100 to 2000 (7 to 140)	Brass	4.2 (3.1)	3450	Direct, Gas
<b>3DX</b>						
3DX25GSI	2.5 (9.5)	100 to 2500 (7 to 175)	Brass	4.3 (3.2)	3450	Direct, Gas
3DX30GSI	3.0 (11.4)	100 to 2500 (7 to 175)	Brass	5.1 (3.8)	3450	Direct, Gas
<b>3SP</b>						
3SP30G1I	3.0 (11.4)	100 to 3000 (7 to 210)	Brass	6.2 (4.6)	3400	Direct, Gas
3SP35G1I	3.5 (13.2)	100 to 2500 (7 to 175)	Brass	6.0 (4.5)	3400	Direct, Electric
<b>66DX</b>						
66DX30G1I	3.0 (11.4)	100 to 4000 (7 to 275)	Brass	8.2 (6.1)	3400	Direct, Gas
66DX35G1I	3.5 (13.2)	100 to 4000 (7 to 275)	Brass	9.6 (7.2)	3400	Direct, Gas
66DX40G1I	4.0 (15.0)	100 to 4000 (7 to 275)	Brass	11.0 (8.2)	3400	Direct, Gas

Detailed Data Sheets are available for each model at [www.catpumps.com/data sheets](http://www.catpumps.com/data sheets).



# Versatile Direct-Drive Pumps



2SF10ES



2SFX



Model 4SF40ELS

*Industrial Duty  
Direct-Drive  
Pump*

## SF DIRECT-DRIVE TRIPLEX PLUNGER PUMP SELECTION

PUMP MODEL	Flow GPM (L/M)	Pressure PSI (BAR)	Manifold Material	Horsepower HP (kW)	RPM	Drive Type
<b>2SF</b>						
2SF10ES	1.0 (3.8)	100 to 2000 (7 to 140)	Brass	1.4 (1.0)	3450	Direct, Electric
2SF20ES	2.0 (7.6)	100 to 2000 (7 to 140)	Brass	2.7 (2.0)	3450	Direct, Electric
2SF22ES	2.2 (8.3)	100 to 2000 (7 to 140)	Brass	3.0 (2.2)	3450	Direct, Electric
2SF22ELS	2.2 (8.3)	100 to 2000 (7 to 140)	Brass	3.0 (2.2)	1725	Direct, Electric
2SF25ELS	2.5 (9.5)	100 to 1500 (7 to 105)	Brass	2.6 (1.9)	1725	Direct, Electric
2SF29ELS	2.85 (10.8)	100 to 1500 (7 to 105)	Brass	2.9 (2.1)	1725	Direct, Electric
2SF30ES	3.0 (11.4)	100 to 1500 (7 to 105)	Brass	3.1 (2.3)	3450	Direct, Electric
2SF30GS	3.0 (11.4)	100 to 2000 (7 to 140)	Brass	4.1 (3.1)	3450	Direct, Gas
2SF35ES	3.5 (13.2)	100 to 1500 (7 to 105)	Brass	3.6 (2.7)	3450	Direct, Electric
2SF35GS	3.5 (13.2)	100 to 2000 (7 to 140)	Brass	4.8 (3.6)	3450	Direct, Gas
<b>2SFX</b>						
2SFX20ES	2.0 (7.6)	100 to 2000 (7 to 140)	Brass	2.7 (2.0)	3450	Direct, Electric
2SFX22ES	2.2 (8.3)	100 to 2000 (7 to 140)	Brass	3.0 (2.2)	3450	Direct, Electric
2SFX25ES	2.5 (9.5)	100 to 1500 (7 to 105)	Brass	2.6 (1.9)	3450	Direct, Electric
2SFX29ELS	2.85 (10.8)	100 to 1500 (7 to 105)	Brass	2.9 (2.1)	1725	Direct, Electric
2SFX30ES	3.0 (11.4)	100 to 1500 (7 to 105)	Brass	3.1 (2.3)	3450	Direct, Electric
2SFX22GS	2.2 (8.3)	100 to 2000 (7 to 140)	Brass	3.0 (2.2)	3450	Direct, Gas
2SFX25GZ	2.5 (9.5)	100 to 2500 (7 to 175)	Brass	4.3 (3.2)	3450	Direct, Gas
2SFX30GS	3.0 (11.4)	100 to 2000 (7 to 140)	Brass	4.1 (3.1)	3450	Direct, Gas
2SFX30GZ	3.0 (11.4)	100 to 2500 (7 to 175)	Brass	5.1 (3.8)	3450	Direct, Gas
2SFX35GS	3.5 (13.2)	100 to 2000 (7 to 140)	Brass	4.8 (3.6)	3450	Direct, Gas
<b>4SF</b>						
4SF32ELS	3.2 (12.1)	100 to 3500 (7 to 245)	Brass	7.7 (5.7)	1725	Direct, Electric
4SF40ELS	4.0 (15.0)	100 to 3500 (7 to 245)	Brass	9.6 (7.2)	1725	Direct, Electric
4SF45ELS	4.5 (17.0)	100 to 3000 (7 to 210)	Brass	9.2 (6.9)	1725	Direct, Electric
4SF50ELS	5.0 (19.0)	100 to 3000 (7 to 210)	Brass	10.3 (7.7)	1725	Direct, Electric
4SF30GS1	3.0 (11.4)	100 to 3500 (7 to 245)	Brass	7.2 (5.4)	3200	Direct, Gas
4SF35GS1	3.5 (13.2)	100 to 3500 (7 to 245)	Brass	8.4 (6.3)	3200	Direct, Gas
4SF40GS1	4.0 (15.0)	100 to 3500 (7 to 245)	Brass	9.6 (7.2)	3200	Direct, Gas
4SF45GS1, GS118	4.5 (17.0)	100 to 3000 (7 to 210)	Brass	9.2 (6.9)	3200	Direct, Gas
4SF50GS1	5.0 (19.0)	100 to 3000 (7 to 210)	Brass	10.3 (7.7)	3200	Direct, Gas

Detailed Data Sheets are available for each model at [www.catpumps.com/data sheets](http://www.catpumps.com/data sheets).



# Mid-Frame Heavy-Duty Piston Pumps

*Superior  
Suction  
Capability  
and Extreme  
Durability*



Model 623



280

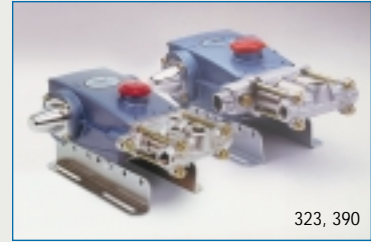

323, 390

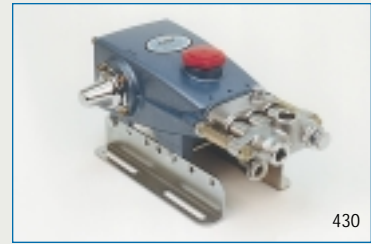

430

## 3, 4, 5, AND 10 FRAME TRIPLEX PISTON PUMP SELECTION

PUMP MODEL	Flow GPM (L/M)	Pressure PSI (BAR)	Manifold Material	Horsepower HP (kW)	RPM	Drive Type
<b>3 Frame</b>						
280	3.0 (11.4)	100 to 1000 (7 to 70)	Brass	2.1 (1.6)	1330	Belt
281	3.0 (11.4)	100 to 1000 (7 to 70)	SS	2.1 (1.6)	1330	Belt
290	3.5 (13.2)	100 to 1200 (7 to 85)	Brass	2.9 (2.2)	1200	Belt
290C1	3.5 (13.2)	100 to 1200 (7 to 85)	Brass	2.9 (2.2)	1200	Clutch-12 VDC
291	3.5 (13.2)	100 to 1200 (7 to 85)	SS	2.9 (2.2)	1200	Belt
<b>4 Frame</b>						
333	4.0 (15.0)	100 to 1200 (7 to 85)	Brass	3.3 (2.4)	1070	Belt
331	4.0 (15.0)	100 to 1200 (7 to 85)	SS	3.3 (2.4)	1070	Belt
430	5.0 (19.0)	100 to 1000 (7 to 70)	Brass	3.4 (2.5)	1040	Belt
431	5.0 (19.0)	100 to 1000 (7 to 70)	SS	3.4 (2.5)	1040	Belt
<b>5 Frame</b>						
323	5.0 (19.0)	100 to 1500 (7 to 105)	Brass	5.1 (3.8)	1000	Belt
390	12.0 (45.0)	100 to 600 (7 to 40)	Brass	4.9 (3.6)	1200	Belt
<b>10 Frame</b>						
623	6.0 (23.0)	100 to 1200 (7 to 85)	Brass	4.9 (3.6)	850	Belt
621	6.0 (23.0)	100 to 1200 (7 to 85)	SS	4.9 (3.6)	850	Belt
820	10.0 (38.0)	100 to 1000 (7 to 70)	Brass	6.9 (5.1)	940	Belt
821	10.0 (38.0)	100 to 1000 (7 to 70)	SS	6.9 (5.1)	940	Belt
1010	13.0 (49.0)	100 to 700 (7 to 50)	Brass	6.2 (4.6)	900	Belt
1011	13.0 (49.0)	100 to 700 (7 to 50)	SS	6.2 (4.6)	900	Belt

NOTE: SS=316 stainless steel manifolds, standard chromeplated 304 stainless steel cylinder and sleeves and 304 stainless steel valves and seats.

Detailed Data Sheets are available for each model at [www.catpumps.com/data sheets](http://www.catpumps.com/data sheets).



# Large Frame Industrial-Duty Piston Pumps

*High Flow  
with  
Excellent  
Suction  
Capability*

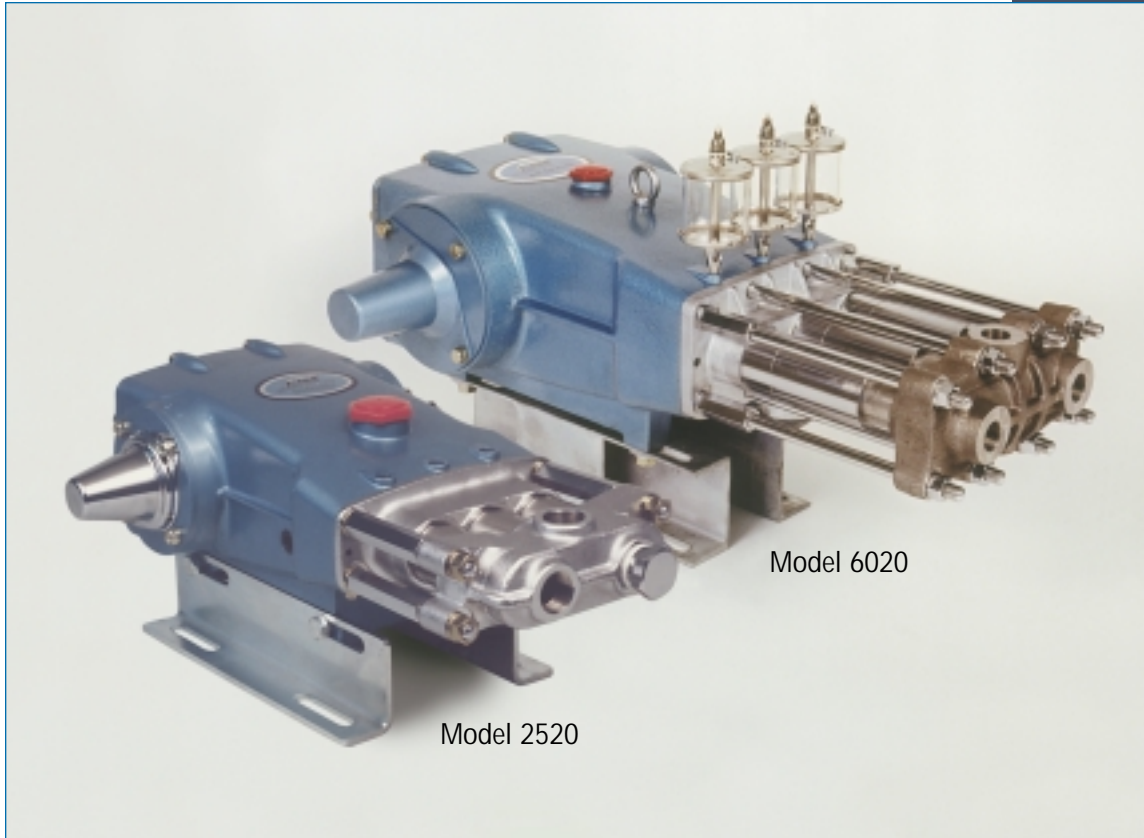

**25 AND 60 FRAME TRIPLEX PISTON PUMP SELECTION**

PUMP MODEL	Flow		Pressure		Manifold Material	Horsepower	RPM	Drive Type
	GPM	(L/M)	PSI	(BAR)		HP (kW)		
<b>25 Frame</b>								
1020	10.0	(38.0)	100 to 1200	(7 to 85)	Brass	8.2 (6.1)	720	Belt
1520	15.0	(57.0)	100 to 1000	(7 to 70)	Brass	10.3 (7.7)	830	Belt
1521	15.0	(57.0)	100 to 1000	(7 to 70)	SS	10.3 (7.7)	830	Belt
2520	25.0	(95.0)	100 to 800	(7 to 55)	Brass	13.7 (10.2)	772	Belt
2521	25.0	(95.0)	100 to 800	(7 to 55)	SS	13.7 (10.2)	772	Belt
2520C	25.0	(95.0)	100 to 800	(7 to 55)	Brass	13.7 (10.2)	772	Belt
<b>60 Frame</b>								
6020	60.0	(227.0)	100 to 1000	(7 to 70)	Brass	41.1 (30.6)	500	Belt
6021	60.0	(227.0)	100 to 1000	(7 to 70)	SS	41.1 (30.6)	500	Belt
6024	12.0	(45.0)	100 to 5000	(7 to 345)	Brass/SS	41.1 (30.6)	500	Belt
6040	40.0	(151.0)	100 to 1500	(7 to 105)	Brass	41.1 (30.6)	500	Belt
6041	40.0	(151.0)	100 to 1500	(7 to 105)	SS	41.1 (30.6)	500	Belt
6044	20.0	(76.0)	100 to 3000	(7 to 210)	Brass/SS	41.1 (30.6)	500	Belt

NOTE: SS=316 stainless steel manifolds, standard chromeplated 304 stainless steel cylinder and sleeves and 304 stainless steel valves and seats.

Detailed Data Sheets are available for each model at [www.catpumps.com/data sheets](http://www.catpumps.com/data sheets).



# Specialized Pumps and Motorized Units

*Triplex  
Pumps for  
Specialized  
Applications*



Model 5CP2140WCSBH53  
Motorized Pump Units Include  
Flex Coupling and Bell Housing



1LX100



Clutch Driven



2DX15ES.MIST

## SPECIALIZED TRIPLEX PLUNGER PUMP SELECTION

PUMP MODEL	Flow GPM (L/M)	Pressure PSI (BAR)	Manifold Material	Horsepower HP (kW)	RPM	Drive Type
<b>LX Axial Triplex Plunger Pumps</b>						
1LX100	1.0 (3.8)	100 to 500 (7 to 35)	RTP	0.34 (0.25)	1725	Direct, Electric
1LX125	1.25 (4.75)	100 to 500 (7 to 35)	RTP	0.42 (0.31)	1725	Direct, Electric
1LXB100	1.0 (3.8)	100 to 500 (7 to 35)	RTP	0.34 (0.25)	1725	Belt
<b>Clutch Driven Triplex Plunger Pumps</b>						
340C1	4.0 (15.0)	100 to 1800 (7 to 125)	Brass	5.0 (3.7)	1725	Clutch-12 VDC
3CP1120C1	4.2 (16.0)	100 to 2200 (7 to 155)	Brass	6.3 (4.7)	1725	Clutch-12 VDC
5CP2150WC1	5.0 (19.0)	100 to 2000 (7 to 140)	W770	6.9 (5.1)	1725	Clutch-12 VDC
5CP3120CSC2	4.5 (17.0)	100 to 3500 (7 to 245)	Brass	10.8 (8.0)	2645	Clutch-12 VDC
290C1	3.5 (13.2)	100 to 1200 (7 to 85)	Brass	2.9 (2.2)	1200	Clutch-12 VDC
<b>Motorized Pump Units with Flex Coupling and Bell Housing Mounting*</b>						
340BH53	4.0 (15.0)	100 to 1800 (7 to 125)	Brass	5.0 (3.7)	1725	FC w/BH
340WBH53	4.0 (15.0)	100 to 1800 (7 to 125)	W770	5.0 (3.7)	1725	FC w/BH
350BH53	5.0 (19.0)	100 to 1460 (7 to 100)	Brass	5.0 (3.7)	1725	FC w/BH
350WBH53	5.0 (19.0)	100 to 1460 (7 to 100)	W770	5.0 (3.7)	1725	FC w/BH
5CP2140WCSBH53	4.0 (15.0)	100 to 1800 (7 to 125)	W770	5.0 (3.7)	1725	FC w/BH
5CP2150WBH53	5.0 (19.0)	100 to 1460 (7 to 100)	W770	5.0 (3.7)	1725	FC w/BH
<b>.MIST Low Flow High Pressure Triplex Plunger Pumps</b>						
1DX03ELS.MIST	0.3 (1.13)	100 to 2000 (7 to 140)	Brass	.42 (0.31)	1725	Direct, Electric
2DX05ELS.MIST	0.5 (1.89)	100 to 2000 (7 to 140)	Brass	.68 (0.51)	1725	Direct, Electric
2DX15ES.MIST	1.5 (5.7)	100 to 2000 (7 to 140)	Brass	2.0 (1.5)	3450	Direct, Electric
2DX20ES.MIST	2.0 (7.6)	100 to 2000 (7 to 140)	Brass	2.7 (2.0)	3450	Direct, Electric
2DX27ES.MIST	2.7 (10.2)	100 to 2000 (7 to 140)	Brass	3.7 (2.8)	3450	Direct, Electric

Detailed Data Sheets are available for each model at [www.catpumps.com/data sheets](http://www.catpumps.com/data sheets).

\*Additional models available.





## Customized Industrial Duty Power Units

---

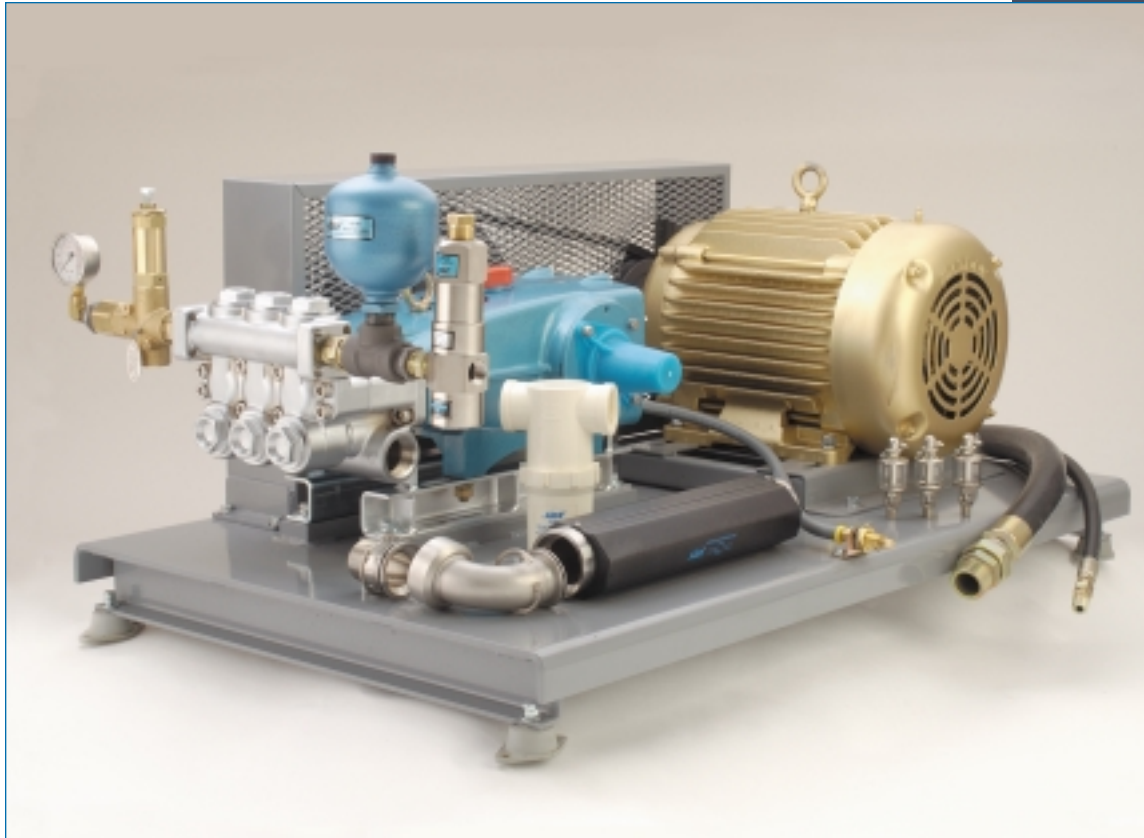

*Fully  
Engineered  
Customer  
Specified  
Packages*

Custom Power Units offer the convenience of a professionally engineered and tested assembled package eliminating design, sourcing, fabrication and testing from your schedule. Most Power Units are available for shipment in 2-8 weeks. Let us help you design your next high pressure system. Complete our Power Unit quotation form on our [web site](#) under Power Units or in the **Power Unit Brochure**.

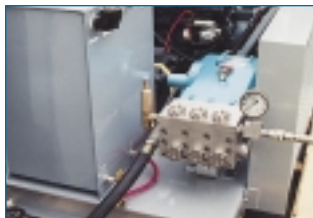

- ▶ Heavy-duty horizontal or stacked base for maximum weight load and minimum flexing.
- ▶ Heavy-duty bolt-down shock mounts provide easy leveling and shock absorption.
- ▶ Flexible drive options including 50 or 60Hz electric motor, variable frequency drive, gas or diesel engines, or hydraulic motor drives.
- ▶ Primary pressure regulating valve and secondary safety relief valve provide system pressure setting and protection.
- ▶ Captive acceleration tube (C.A.T.) as needed to minimize inlet surging, spikes and cavitation.
- ▶ Bladder type, nitrogen pre-charged pulsation dampeners increase the life of the pump and system components.
- ▶ System options such as handle and wheels for portability, custom paint, enclosures, and additional system accessories are available.



**CAT  
PUMPS**  
The Pumps with Nine Lives  
[www.catpumps.com](http://www.catpumps.com)

# High Flow Stainless Steel Centrifugal Pumps

High  
Efficiency  
Pump and  
Motor  
Combinations

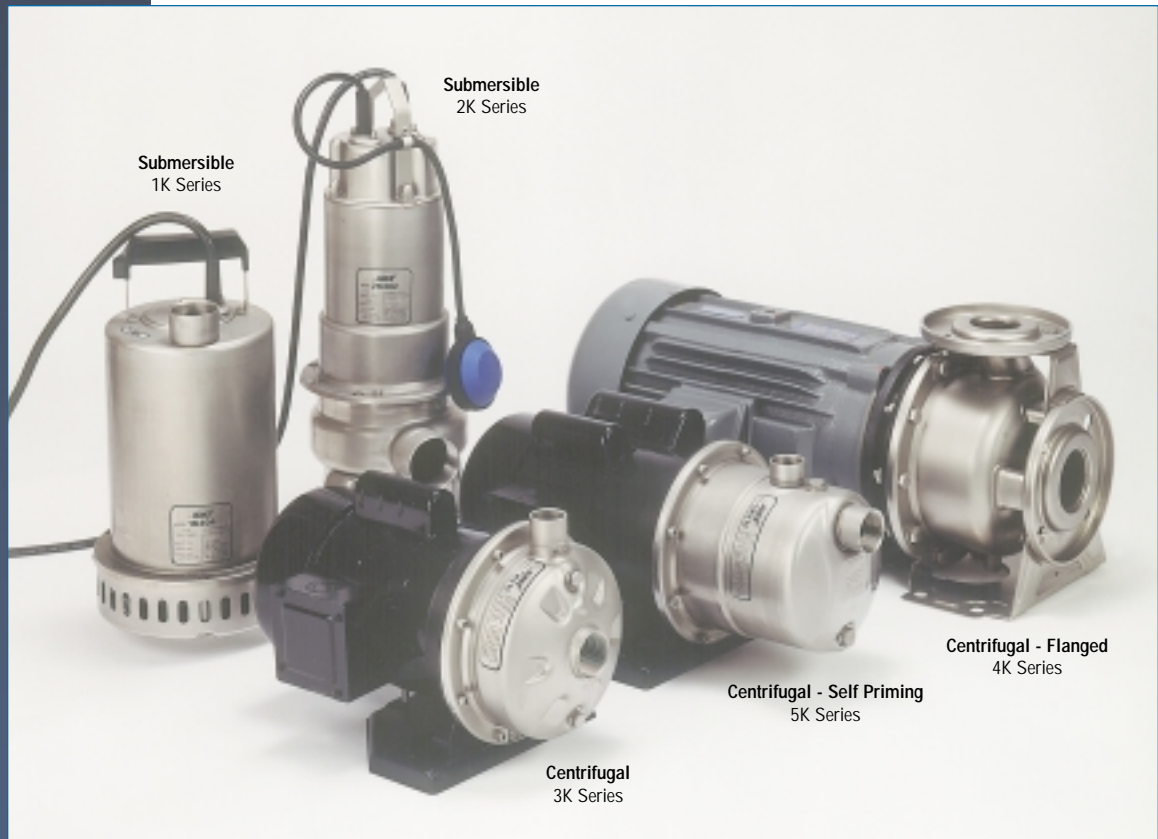

## K-SERIES STAINLESS STEEL CENTRIFUGAL PUMP SELECTION

PUMP MODEL	Flow GPM (L/M)	Pressure PSI (BAR)	Casing Material	Ports Inlet x Discharge	Horsepower HP (kW)	Motor Type
<b>Submersible Pumps Complete with Integral Motor and Seal</b>						
1K100	45 (170)	10 (0.69)	304S	1-1/4" NPT	1/3 (0.2)	115V 1PH Auto
1K201	73 (276)	17 (1.17)	304S	1-1/2" NPT	1/2 (0.4)	115V 1PH Auto
1K203	73 (276)	17 (1.17)	304S	1-1/2" NPT	1/2 (0.4)	115V 1PH Manual
1K205	73 (276)	17 (1.17)	304S	1-1/2" NPT	1/2 (0.4)	460V 3PH Manual
1K301	74 (280)	21 (1.46)	304S	1-1/2" NPT	3/4 (0.6)	115V 1PH Auto
1K303	74 (280)	21 (1.46)	304S	1-1/2" NPT	3/4 (0.6)	115V 1PH Manual
1K305	74 (280)	21 (1.46)	304S	1-1/2" NPT	3/4 (0.6)	460V 3PH Manual
2K102	88 (333)	9 (0.62)	304S	2" NPT	1/2 (0.4)	208-230V 1PH Auto
2K103	88 (333)	9 (0.62)	304S	2" NPT	1/2 (0.4)	208-230V 1PH Manual
2K200	100 (378)	11 (0.76)	304S	2" NPT	1 (0.8)	115V 1PH Auto
2K202	100 (378)	11 (0.76)	304S	2" NPT	1 (0.8)	208-230V 1PH Auto
<b>Centrifugal Motorized Units with TEFC Motor and Chemical Resistant Seal</b>						
3K392BT0	52 (195)	13 (0.90)	304S	1-1/2 x 1" NPT	1/2 (0.4)	56FR Electric 1PH
3K392BT3	52 (195)	13 (0.90)	304S	1-1/2 x 1" NPT	1/2 (0.4)	56FR Electric 3PH
3K142MT1	63 (238)	32 (2.20)	304S	1-1/4 x 1" NPT	1 (0.8)	56FR Electric 1PH
3K142MT3	63 (238)	32 (2.20)	304S	1-1/4 x 1" NPT	1 (0.8)	56FR Electric 3PH
3K152MT1	63 (238)	44 (3.00)	304S	1-1/4 x 1" NPT	1-1/2 (1.1)	56FR Electric 1PH
3K152MT3	63 (238)	44 (3.00)	304S	1-1/4 x 1" NPT	1-1/2 (1.1)	56FR Electric 3PH
3K132MT2	38 (144)	62 (4.30)	304S	1-1/4 x 1" NPT	2 (1.5)	56FR Electric 1PH
3K132MT3	38 (144)	62 (4.30)	304S	1-1/4 x 1" NPT	2 (1.5)	56FR Electric 3PH
3K162MT3	63 (238)	63 (4.34)	304S	1-1/4 x 1" NPT	3 (2.2)	56FR Electric 1PH
<b>Centrifugal - Flanged Motorized Units with TEFC Motor and Chemical Resistant Seal</b>						
4K132MT3	135 (511)	76 (5.20)	304S	2 x 1-1/4" ANSI	5 (3.7)	182FR Electric 3PH
4K142MT3	153 (579)	90 (6.20)	304S	2 x 1-1/4" ANSI	7-1/2 (5.6)	213FR Electric 3PH
4K192MT3	250 (946)	82 (5.60)	304S	2-1/2 x 1-1/2" ANSI	10 (7.5)	215FR Electric 3PH
4K252BT3	380 (1438)	84 (5.80)	304S	2-1/2 x 2" ANSI	15 (11.2)	215FR Electric 3PH
<b>Centrifugal - Self-Priming Motorized Units with TEFC Motor and Chemical Resistant Seal</b>						
5K112MT1	18.5 (70)	56 (3.90)	304S	1-1/4 x 1" NPT	1 (0.8)	56FR Electric 1PH
5K112MT3	18.5 (70)	56 (3.90)	304S	1-1/4 x 1" NPT	1 (0.8)	56FR Electric 3PH
5K122MT2	18.5 (70)	82 (5.60)	304S	1-1/4 x 1" NPT	2 (1.5)	56FR Electric 1PH
5K122MT3	18.5 (70)	82 (5.60)	304S	1-1/4 x 1" NPT	2 (1.5)	56FR Electric 3PH

Detailed Data Sheets are available for each model at [www.catpumps.com/data sheets](http://www.catpumps.com/data sheets).



## Heavy Duty Accessories

*Complete Line  
of  
CAT PUMP  
System  
Accessories*



CAT PUMPS offers a complete line of accessories to match the flow and pressure requirements of each pump model. Our accessories are used to protect the pump from excessive pressures, overheating and abrasive liquids, while others enhance application performances. Using CAT PUMPS accessories will ensure optimum pump performance and reduce maintenance expense and downtime.

For technical data sheets contact CAT PUMPS at (763) 780-5440 or visit our web site.



- ▶ Good lubrication is one of the easiest and least expensive preventative maintenance steps for your pump. CAT PUMPS crankcase oil is a special blend, multi-viscosity petroleum based hydraulic lubricant for your CAT PUMP.



- ▶ Pressure Regulators offer pump protection against pressure spikes and maintain full system pressure. All systems require a primary pressure regulating device and a secondary safety relief.



- ▶ Pulsation Dampeners reduce pulsation and increase the life of the pump and system components. Dampeners are pre-charged with nitrogen to eliminate moisture and extend bladder life.



**CAT PUMPS**  
The Pumps with Nine Lives  
[www.catpumps.com](http://www.catpumps.com)

# Service and Product Available On-line

## www.catpumps.com



Applications and innovative solutions.

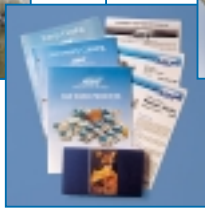

Technical information, chemical compatibility charts and product data in PDF format.



Find the right CAT PUMP to meet your requirements.



Request a Power Unit Quote.

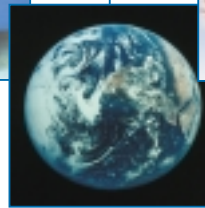

Find the sales, service and technical support nearest you.



Find answers to your performance questions.



Assistance in diagnosing and servicing your pump or system.

## Service and Product Available Worldwide

When you need a part for your CAT PUMP you can count on our extensive worldwide network of sales and service representatives. Each location is equipped with pumps, complementary accessories and service parts. Each location is trained to assist you in the selection, installation and maintenance of your CAT PUMPS. No matter where you are, we're there when you need us.

Products described hereon are covered by one or more of the following U.S. patents 3558244, 3652188, 3809508, 3920356, 3930756 and 5035580

**World Headquarters**  
CAT PUMPS



*The Pumps with Nine Lives*

**CAT PUMPS (U.K.) LTD.**

