

Clean Compressed Air

The Norgren guide to effective air preparation

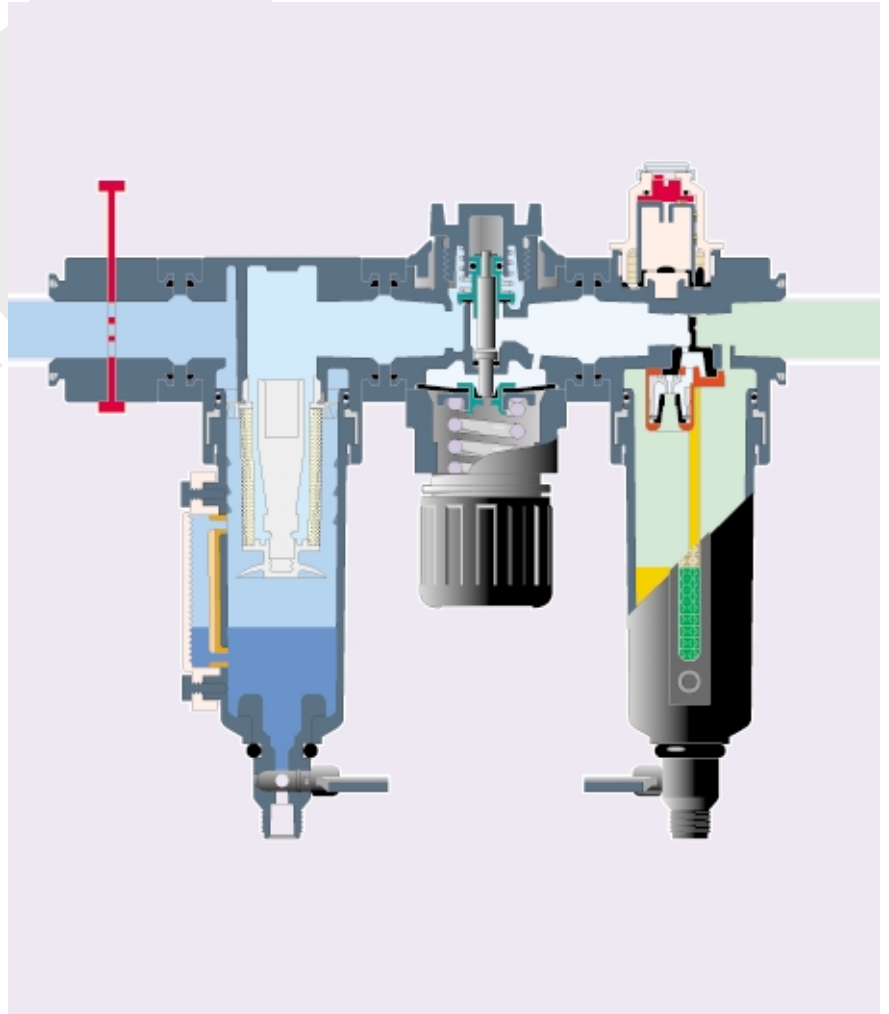

The air leaving a compressor is hot, dirty, wet and generally at a higher pressure than the downstream equipment requires. A typical 50 dm³/sec (100 scfm) compressor will push 4 500 litres of water and 8 litres of degraded compressor oil into the system in a year along with considerable amounts of dirt particles. Before this air can be used it needs to be treated to remove the contaminants, have its pressure reduced to the right level, and in many cases have oil added to lubricate downstream equipment.

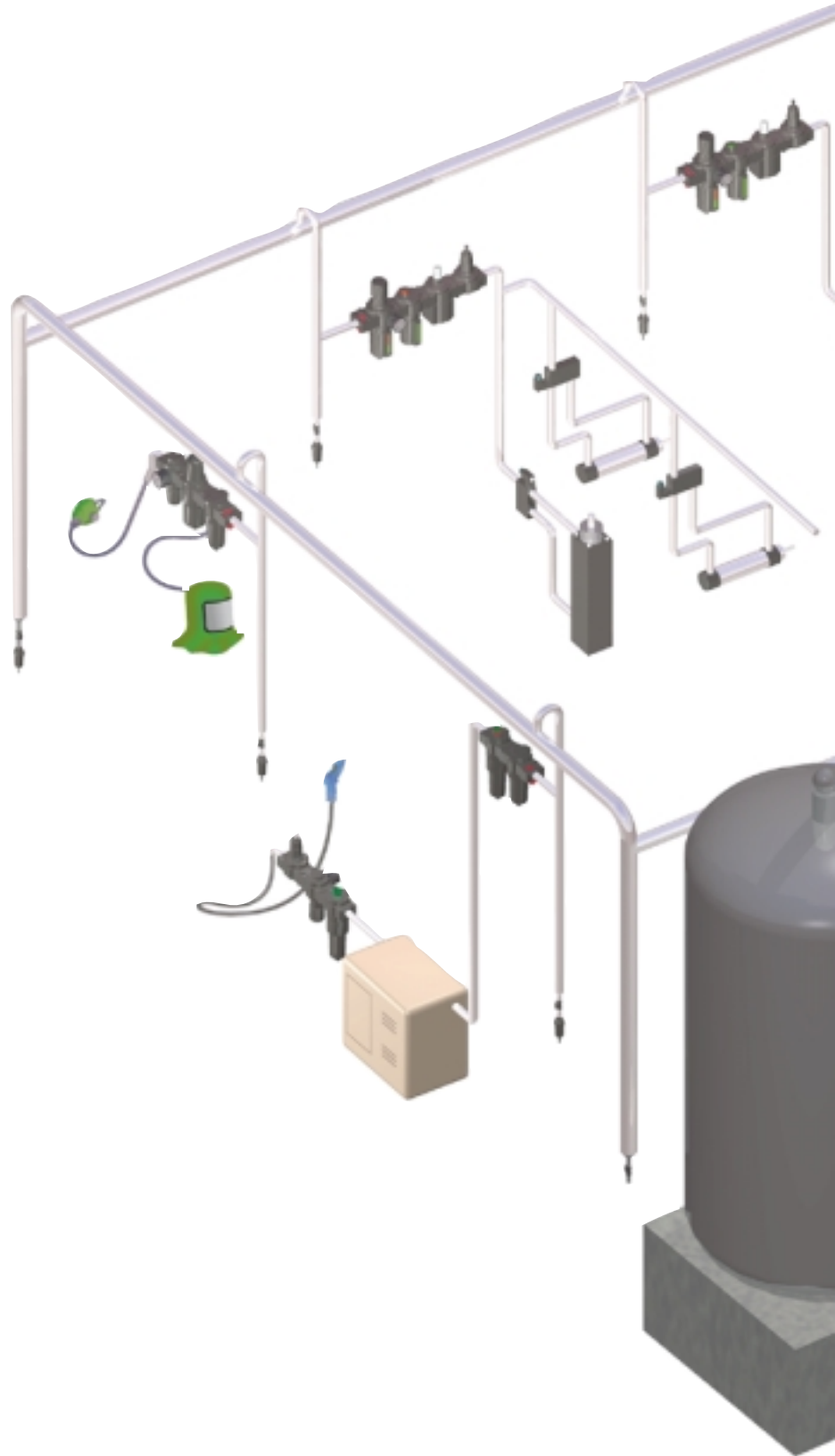
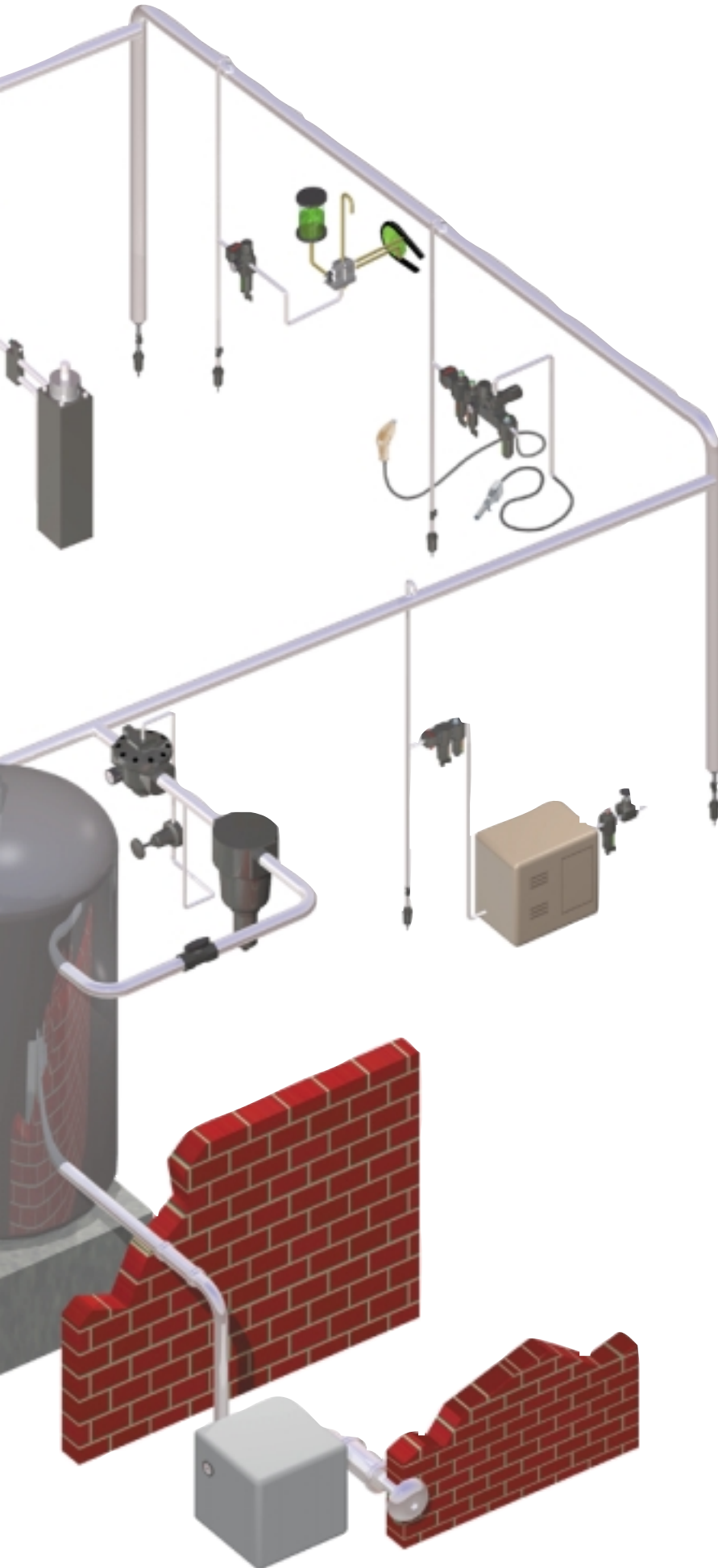

Figure 1.
Compressed air installation, showing examples
of air preparation applications. See details on
pages 4 and 5.



APPLICATIONS

4 ~ 5

REMOVING CONTAMINANTS

6 ~ 10

PRESSURE CONTROL

11 ~ 13

LUBRICATION

14 ~ 15

PROTECTING SYSTEMS, PERSONNEL AND THE ENVIRONMENT

16 ~ 17

SAFE SYSTEMS

18

NORGREN AIR PREPARATION PRODUCT OVERVIEW

19 ~ 21

GLOSSARY

22

REFERENCE TABLES

23

Compressed air is often wrongly assumed to be a cheap or even 'free' source of power. In fact it can be 10 times as expensive as electricity by the time all generation, transmission, treatment and system costs are taken into account. Good air preparation must therefore consider the energy consumption of the system and air treatment equipment.

The process of air preparation has been at the core of Norgren's business for over 70 years. The aim of this booklet is to offer guidance on the correct, economic and safe treatment of compressed air in industrial applications. Here we can only provide a brief summary of the extensive experience Norgren has as a world leader in FRL technology.

For more detailed advice contact your local Norgren Technical Sales Centre,
Tel: 0345 662266.

APPLICATIONS

The following section shows several typical systems of a generic type and the equipment normally used for the application. Remember every system should be treated on its merits and broken down into several elements to ensure optimum installation, running and maintenance costs are achieved.

The applications below are typically branches taken off a large works distribution mains and isolating valves are usually placed in front of all branches to permit isolation from the mains to allow for maintenance to take place without recourse to complete plant shut-down.

For expert advice on the right equipment for your application contact your local Norgren Technical Sales Centre,
Tel: 0345 662266.

General Pneumatic Circuits:

eg: directional control valves and cylinders, in multi-valve circuits, machine cleaning, air motors and high speed tools.

A Micro-Fog lubricator is required for the several varying flow paths to ensure full lubrication. (Figure 2)

Figure 2.

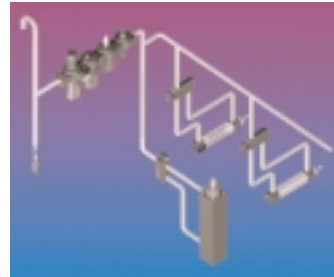

Shut-off valve, filter/reg, Micro-Fog lubricator, soft start/dump, relief valve.

Multiple Simple Applications:

eg: OEM machines.

It is often a case that with fairly simple machines, lubricated air is require for valving and pneumatic circuitry and oil-free air for air bearings. To keep costs low two separate lines are unnecessary and a typical arrangement from one air supply only can be arranged as shown.

Other elements such as pressure switches and check valves may be made available within modular systems. (Figure 3).

Figure 3.

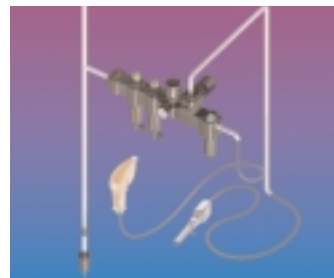

Shut-off valve, filter/regulator, oil removal filter, porting block, Micro-Fog lubricator.

Breathing Air:

eg: face masks and hoods, air agitation.

The typical application assumes that air intakes are of a reasonable quality with no CO or CO₂ contamination. It may in some instances be a consideration to remove water vapour. (Figure 4)

Figure 4.

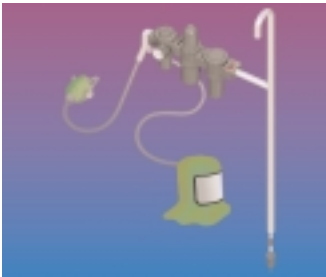

Shut-off valve, general purpose filter, Ultrafine filter, regulator.

Heavy Duty Lubrication:

eg: large slow moving cylinders.

In such applications large amounts of lubricant are required for effective lubrication. Again a soft start/dump valve is shown but is dependent upon the application. (Figure 6).

Figure 6.

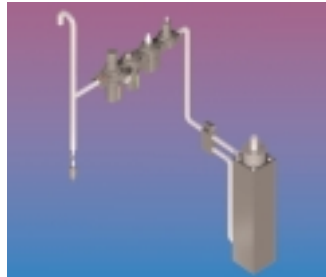

Shut-off valve, filter/reg, Oil-Fog lubricator, soft start/dump valve, relief valve.

Direct Injection Lubrication:

eg: conveyor chains.

The application does not allow for 'fog' type lubrication because of the surrounding environment and absence of a lubrication chamber. (Figure 8).

Figure 8.

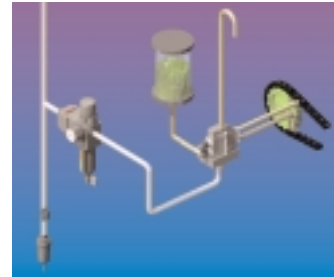

Shut-off valve, filter/reg + direct injection lubricator.

Oil-Free Applications:

eg: paint spraying, foodstuffs, film processing, powders.

These applications need to be free from any water deposits in the downstream system. For many installations this will require air drying. The drying medium (for desiccant or deliquescent dryers) will need protecting from oil to allow it to work efficiently and the downstream system will also need protection from accidental migration of the material into it. A typical arrangement would be as figure 5 and in some instances it might be worth considering an oil vapour removal filter too.

Figure 5.

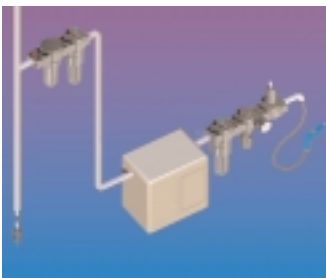

Shut-off valve, general purpose filter, oil removal filter, drier, oil removal filter, regulator, relief valve.

Critical Pressure Control (Instrumentation):

eg: precision regulation, fluidic systems, air gauging, process control.

A typical arrangement is shown, where oil aerosols which can prevent fast response of downstream devices, need to be removed. Dependant upon air quality drying may not be required. (Figure 7)

Figure 7.

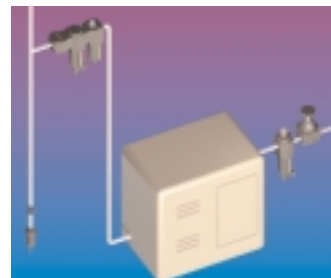

Shut-off valve, general purpose filter, oil removal filter, drier, oil removal filter, precision regulator.

Continuous Processes:

eg: paper mills, chemical plants.

Another facet of Norgren's Olympian Plus is the ability to make duplex systems. This is invaluable for systems which cannot be shut-down, such as continuous process plant. Two identical air sets are joined together and one may be isolated (and serviced) whilst the other set is in operation. (Figure 9).

Figure 9.



Duplex system: shut-off valve, filter/reg, lubricator, porting block, oil removal filter and shut-off valve x 2 with manifold block connectors.

REMOVING CONTAMINANTS

The air produced by a compressor is hot, wet and dirty. The first step in good air preparation is to filter out these contaminants. This section considers the removal of liquid water, water vapour, solid particles and finally oil.

LIQUID WATER

In compressed air systems water vapour exists as a contaminant originating at the compressor outlet in vapour form, but as the air cools, it will exist as both liquid and vapour.

The amount of water vapour that can exist in any given volume of compressed air is directly proportional to the air temperature and inversely proportional to the pressure.

Most liquid water will be present when the temperature is lowest and the pressure is highest and removal at this point will achieve the highest efficiency.

In order to achieve this an essential element of any system following the compressor is an efficient after cooler of sufficient capacity to reduce the temperature of the outgoing air to within 8°C of the temperature of the water entering the after cooler.

The outgoing air should then be piped to a receiver of adequate capacity located in the coolest location available, definitely not within the compressor house itself. This will permit further cooling of the air to occur and therefore more condensation.

Generally the capacity of the receiver is about 30 times greater than the rated free air delivery of the compressor when operating in the 7 bar g region, typical of most industrial air supplies. See figure 10 for a typical compressor installation.

Further cooling may occur in the distribution mains themselves. These should be laid out with a pitch in the direction of air flow so that gravity and air flow will carry water to drain legs located at appropriate sites. Down loops in distribution mains should be avoided, if not locate a drain leg at the down loop. With the exception of drain legs all air take-off points from the distribution mains should be taken from the top of the main to prevent water from entering the

take-off lines. See figure 1 for a typical good distribution main arrangement.

As stated earlier most efficient water removal will take place at high pressure, so anything which will produce a pressure drop within the distribution system should be avoided. This will also be a loss of energy to the system and increase the the cost of compressed air generation. Areas to avoid here are complex flow paths with undue bends and inadequately sized piping. See page 23 Reference Data for friction losses in pipe and for recommended pipe flows.

The action of water removal can be achieved by drip leg drains, automatic drain valves and as discussed later, filters. These devices should be located in positions where liquid water is present in amounts large enough to be removed. (See figure 11). Because of the possibility of cooling occurring during the passage of the air through distribution mains and branch lines it is preferable to install smaller individual filters as near to the actual point of air usage as possible, rather than rely on one large filter adjacent to the air receiver. A point to remember is that since most water will be present at higher pressures, always locate filters upstream of any pressure reducing valves.

Filters which have the ability to remove water are designed for efficient water removal and low pressure drop in accordance with the recommended pipe flows (see page 23) and Norgren filters will have high efficiencies up to 200% of this recommended figure.

WATER VAPOUR

A properly designed air line filter of the correct size, in the correct location will effectively and efficiently remove liquid water, but will not reduce the water vapour content of the air. Further air cooling may result in more water condensing out. If complete freedom from water contamination is essential then the water vapour content of the air must be lowered such that the 'Dew Point' of the air is lower than any temperature that the air can be exposed to in the system.

Once all liquid water is removed from compressed air, then normally the air will be completely saturated with water vapour. The particular temperature and pressure at which the compressed air exists at that moment is known as the 'Pressure Dew Point'.

Figure 10.
TYPICAL COMPRESSOR INSTALLATION

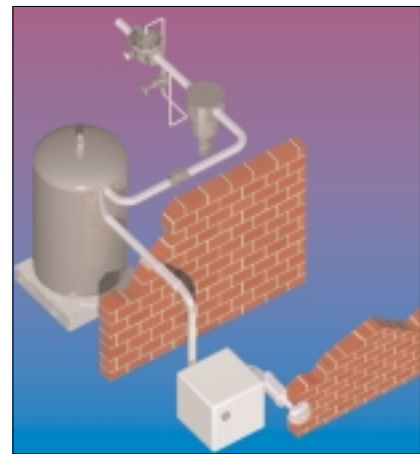
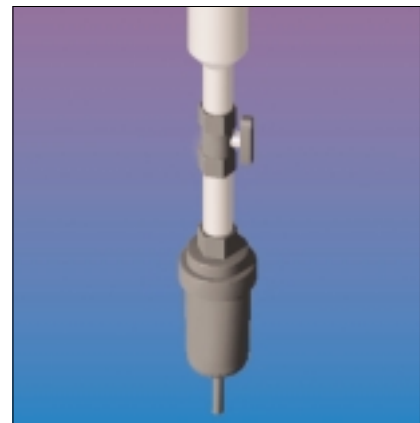

Figure 11.
DRIP LEG DRAIN



Dew Points are normally measured at atmospheric pressure and can be related to Pressure Dew Points through appropriate charts.

In order to remove water vapour from a compressed air system Air Dryers must be employed. The efficiency of these devices is much increased by ensuring that they are not contaminated by liquid water or oil (or combinations - emulsions) and are supplied with air at the lowest possible temperature. So they are additions to the system and not alternatives to filters and after coolers.

There are 3 principle types of Air Dryer;

Refrigerant,

Regenerative Adsorbent Desiccant
and Deliquescent Absorbent Dryers

(The general comparative abilities and comparative costs are tabled in the Reference Data on page 23)

In order to keep the costs of air drying to a minimum consider the following:-

- a) Does the particular process require air drying or will efficient after coolers, receivers and filters suffice?
- b) Do not specify extremely low Dew Points if the process does not warrant them.
- c) Limit the volume of air being dried to that actually needed for the particular process with an adequate margin for future expansion. This may indicate only one area of a process plant need employ a dryer.
- d) The major requirement for air dryers in general industrial applications is where high ambient temperatures exist.

Figure 12. PARTICLE SIZES

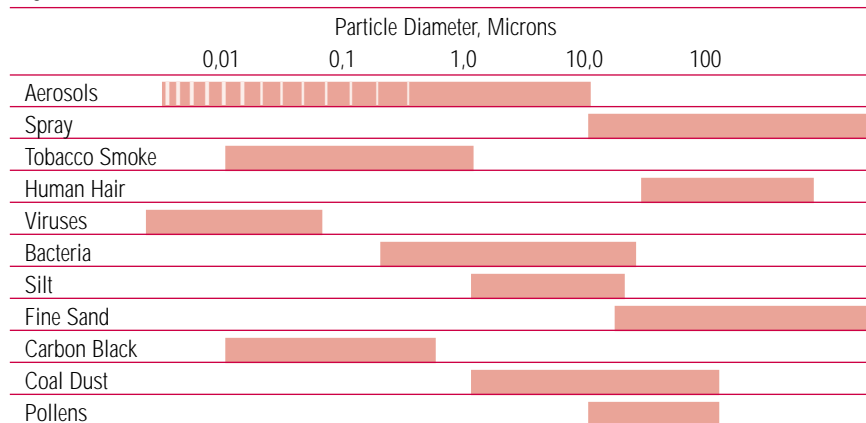

SOLID PARTICLES

Like water, solid particles exist in any compressed air system regardless of the type of compressor. These can arise from four principle sources:-

- a) Atmospheric dirt inhaled at the compressor inlet port.
- b) Corrosion products due to the action of water and weak acids, formed by the interaction of water and gases such as sulphur dioxide inhaled by the compressor.
- c) Carbon products formed by the action of the heat of compression on the lubricating oil or the normal wear of the carbon piston rings used in some types of oil free compressors.
- d) Particles originating from the mechanical fixing of the metal pipe work and components into the air distribution system.

The size of dirt particles covers a very wide range from several hundred to below one micron (see figure 12) and the level of filtration depends upon the degree of cleanliness needed for the particular process involved. Generally it is inadvisable to provide finer filtration than is absolutely necessary because the finer the filtration, the greater the quantity of dirt trapped by the filter element and the more rapidly it will become blocked.

Particles can be broken broadly into two groups, coarse (40 microns and above) or fine. Most normal air line filters will satisfactorily remove particles down to 40 microns.

Figure 13. GENERAL PURPOSE FILTER

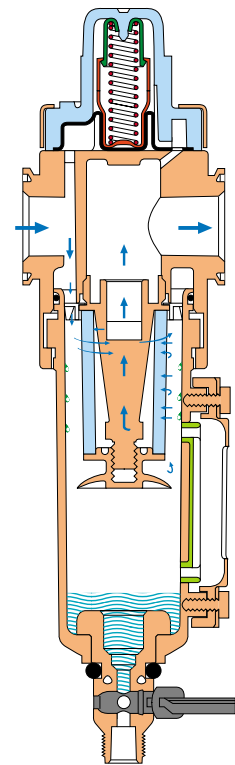

Fine filtration in the region 10 – 25 μm is normally required for high speed pneumatic tools or process control instrumentation. Filtration of 10 μm and below is essential for air bearings and miniature pneumatic motors. Norgren general purpose filters are available with different grades of element to offer these various filtration levels. Some applications may need filtration better than this and indeed for paint spraying, breathing air and food related applications particle removal below 1 μm is also essential. Standard air line filters cannot be used

and high efficiency filters (oil removal/coalescing filters) must be employed. Standard air line filters should still be employed as pre-filters to these high efficiency filters. High efficiency filters will remove these extremely fine particles and if exposed also to the coarser particles they will simply clog and become congested with dirt extremely quickly.

All elements will become blocked in use. The level to which the blocking is acceptable is dependent upon the application and the energy consciousness of the plant operation. Standard filters can be cleaned and reused but in today's environment with labour costs high and spare parts inexpensive it is normally better to replace elements. This will also ensure minimum pressure drop on reinstallation as cleaning at very best will only remove 70% of accumulated particles. High efficiency filter elements cannot be cleaned and must be replaced before they become blocked with dirt.

Under normal usage conditions general purpose filter elements are usually changed before their pressure drop is greater than 0,5 bar, or in routine annual maintenance. The period can always be adjusted by monitoring for critical applications using a service indicator (figure 15).

High efficiency filters should have their elements replaced when a pressure drop of 0,7 bar is achieved. Again a low cost service indicator is often employed. This device has a scale of two colours, usually green/red. The elements should be changed when or before all red is achieved. Electrical service indicators are also available from Norgren, to provide remote signalling. Maintenance schedules can be produced to ensure this 'last chance' situation is not achieved, indeed some applications cannot tolerate even this much pressure drop, especially if this is at the generation point of a large compressed air distribution main as the cost of extra energy alone would be very large.

OIL

The principle source of oil contamination within a compressed air system is from the compressor. An oil lubricated compressor of 50 dm³/s capacity may introduce as much as 0,16 litres of oil per week into the system.

Oil is used for lubrication of the compressor but when it emerges with the compressed air prior to distribution the oil is now in a totally unusable state. Having been subjected to high temperatures during air compression it becomes oxidized and acidic and can be considered as an aggressive contaminant rather than a lubricant and so must be removed.

Normal air line filters will remove sufficient liquid oil (along with water) to leave the air in a suitable condition to supply most pneumatic tools and cylinders, but certain processes demand completely oil-free air.

One solution is to use oil-free compressors. These will still produce air contaminated with dirt and water and it is often more economical to use lubricated compressors in conjunction with after coolers and standard air line filters, only fitting high efficiency oil removal filters at the points in the system which demand oil-free air. This ensures that the amount of air needing special treatment is kept to a minimum by allowing a smaller specialised filter in the affected area and not a large specialised filter for the whole plant.

Oil in a compressed air system can exist in three forms, oil/water emulsions, aerosols (small particles suspended in the air) and oil vapours.

Emulsions can be removed by standard air line filters but the aerosols are our next concern.

Figure 14.
'PURAIRE' COALESCING FILTER

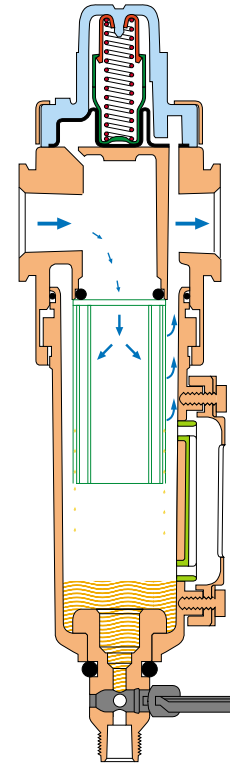

Figure 15.
FILTER SERVICE INDICATOR



OIL AEROSOLS

These particulate oil droplets exist in the airstream and the most troublesome are in the size range 0,01 to 1 micron (approx 90%), the rest may be slightly larger (see figure 12 particle size chart).

Most standard air line filters achieve water removal by centrifugal action but due to their small particle size these aerosols are unaffected and require special coalescing filters.

In addition to removing the oil droplets these filters will also remove minute water droplets, but they must be protected against gross dirt or water contamination by means of standard air line filters mounted immediately upstream (figure 16). It is normally advisable that these filters are capable of removing particles down to 5 microns or less otherwise the coalescing filter may quickly become choked and blocked with dirt, requiring a filter element replacement.

Coalescing filters are normally rated by the amount of air which they can 'process' to achieve a given oil removal performance, normally a maximum remaining oil content in the exit air of 0,01 mg/m³ (or 0,01 ppm). To try to overflow these units will not only result in a greater pressure drop across the unit and therefore extra energy cost but more importantly the remaining oil content will increase. This may be acceptable for some applications where oil removal down to the order of 0,5 mg/m³ is quite adequate to give a degree of protection to a system particularly prone to gross oil contamination.

Figure 19 shows Norgren coalescing filters flow capacities to achieve their given performance.

OIL VAPOUR

For most processes the removal of oil vapour is unnecessary since unlike water vapour, oil vapour exists only in minute quantities and is not objectionable except in circumstances where its odour is unacceptable eg. in food processing, pharmaceutical and beverage industries and breathing air applications.

The most common method of removal is to pass the air through an adsorbing bed, usually of activated carbon, although other materials can be used.

Such vapour removal filters will normally reduce the total remaining oil content when used in conjunction with a pre-filter (general purpose filter) and a coalescing filter to 0,003mg/m³.

A common misconception of these filters is that they will remove carbon monoxide or carbon dioxide - they will not.

As with oil removal (coalescing) filters the vapour removal filters should only be employed where their function is needed, the maximum flow rating is not exceeded and they are preceded by a general purpose and a coalescing filter. This will minimise the size of the filters required and therefore the cost of the installation.

Norgren offers an integrated coalescing and vapour removal filter in the Olympian Plus range. (See figure 17). This includes a colour change service indicator as standard.

The location of the compressor intake may also have an effect on the level of filtration required, if for example the intake is situated by a source of hydrocarbon vapours etc. Clean air intake will reduce the cost of producing clean compressed air.

Figure 16.
OIL REMOVAL FILTER WITH GENERAL PURPOSE PRE-FILTER



Figure 17.
'ULTRAIRE' OIL VAPOUR REMOVAL FILTER

FILTER SELECTION

Once all of the contaminants have been considered the degree of cleanliness of air for each part of an industrial plant or process can be determined. By only employing the correct filters in the right location energy and maintenance costs can be kept to a minimum. The volume of air involved in each stage must always be considered as under-sized, inappropriate filters are a prime cause of high energy costs.

A very general guide to the typical levels of cleanliness required for common processes is given in figure 21. Each application should however be considered on its own merits.

Recommendations on air drying are particularly difficult since this is dependant upon the temperature of the compressed air main adjacent to the application/machine the level of pressure reduction and air flow rate.

For well laid out generation and distribution systems drying is seldom required in countries of typically low to moderate relative humidities and ambient temperatures.

When choosing a filter to clean compressed air ensure:-

- The correct type of filter and element rating is selected for particle removal.
- The liquid removal efficiency is high and that re-entrainment is not possible.
- Ease of maintenance and liquid condensate collection is possible.
- Easy visibility of condensate and/or element ensures that function is achieved or shows if maintenance is required.

This may be a pressure drop device, liquid level indicator or transparent bowl.

In order to aid determining the type of water and particle removal, figure 20 shows ISO 8573 Air Quality Classification.

Figure 18.
GENERAL PURPOSE FILTER FLOWS

| Pipe Size | Unit | Flow (dm ³ /s)* |
|-----------|------|----------------------------|
| 1/8" | F07 | 15 |
| 1/4" | F2G | 30 |
| 1/2" | F64G | 70 |
| | F74G | 83 |
| 1" | F15 | 175 |

*Flow at 6,3 bar and 0,5 bar pressure drop.

Figure 19. HIGH EFFICIENCY FILTER FLOWS

| Pipe Size | Unit | Flow (dm ³ /s)* | Oil Removal Class** |
|-----------|------|----------------------------|---------------------|
| 1/8" | F39 | 2,8 | 2 |
| 1/4" | F72C | 4,5 | 2 |
| 3/8" | F64C | 16 | 2 |
| | F64B | 7 | 1 |
| | F74C | 16 | 2 |
| 1/2" | F64H | 28 | 2 |
| | F64L | 11 | 1 |
| | F74H | 28 | 2 |
| 1" | F53 | 60 | 2 |
| | F52 | 60 | 1 |
| 1 1/2" | F47 | 85 | 2 |
| | F47 | 120 | 3 |
| 2" | F47 | 200 | 2 |
| | F47 | 286 | 3 |

*Flow with 6,3 bar inlet to achieve 'class' requirements.

**See figure 20.

Figure 20.

AIR QUALITY CLASSIFICATIONS ISO 8573

| Quality Class | Dirt Particle Size in Microns | Water Pressure Dew-point °C (ppm vol.) at 7 bar g | Oil (including vapour) mg/m ³ |
|---------------|-------------------------------|---|--|
| 1 | 0,1 | -70 (0,3) | 0,01 |
| 2 | 1 | -40 (16) | 0,1 |
| 3 | 5 | -20 (128) | 1 |
| 4 | 15 | +3 (940) | 5 |
| 5 | 40 | +7 (1 240) | 25 |
| 6 | — | +10 (1 500) | — |

Figure 21.
RECOMMENDED FILTRATION LEVELS.

| Application | Typical Quality Classes | |
|--------------------------------|-------------------------|------|
| | Oil | Dirt |
| Air agitation | 1 | 3 |
| Air bearings | 2 | 2 |
| Air gauging | 2 | 2 |
| Air motors | 4 | 4 |
| Brick and glass machines | 5 | 4 |
| Cleaning of machine parts | 3 | 4 |
| Construction | 4 | 5 |
| Conveying, granular products | 2 | 4 |
| Conveying, powder products | 1 | 3 |
| Fluidics, power circuits | 2 | 5 |
| Fluidics, sensors | 2 | 3 |
| Foundry machines | 4 | 5 |
| Food and beverages | 1 | 1 |
| Hand operated air tools | 5 | 5 |
| Machine tools | 5 | 4 |
| Mining | 5 | 5 |
| Micro-electronics manufacture | 1 | 1 |
| Packaging and textile machines | 5 | 3 |
| Photographic film processing | 1 | 2 |
| Pneumatic cylinders | 3 | 5 |
| Pneumatic tools | 5 | 4 |
| Pneumatic tools (high speed) | 4 | 3 |
| Process control instruments | 2 | 3 |
| Paint spraying | 1 | 1 |
| Sand Blasting | 4 | 5 |
| Welding machines | 5 | 5 |
| General Workshop air | 5 | 4 |

PRESSURE CONTROL

In order to use compressed air most effectively and efficiently it is necessary to reduce the pressure to precisely the level required for its application.

All pneumatic equipment has an optimum operating pressure. Using it at a higher pressure causes excessive wear, with no significant increase in output, whilst wasting the compressed air itself and the cost expended in generating it. If the compressed air is stored at this higher pressure and only used at exactly the lower level required for the application the storage vessel or receiver need only be topped up from some intermediate figure to the full capacity, which is more efficient. In order to achieve this optimum usage the compressor usually operates between two pressure levels, that is the receiver normally has a pressure switch set to give compressor cut-off at the required storage pressure (usually the highest achievable for filtration efficiency) and a lower level usually about 10 - 20% lower. This figure can be adjusted for the optimum when the receiver size, system flow demand and compressor output rating are considered. The outcome of this arrangement is that the compressor is not continually running, using up excess energy, producing more heat which produces more water, which must be removed (extra cost) to supply a system requirement at too high a pressure which causes excessive wear (extra cost) for no increase in output.

A pressure reducing valve can therefore generate cost savings greater than its purchase price in a short time period. Also it is mandatory in such applications as blow guns and cooling nozzles where the use of compressed air at high pressure is potentially hazardous.

Pressure reducing valves or regulators have two principle characteristics which must be considered in establishing which to select, their ability to keep the outlet pressure constant irrespective of the inlet pressure (called the regulation characteristic) and irrespective of the outlet flow (flow characteristic). Standard designs are manufactured which achieve certain levels of the ideal performance on each characteristic. A simple application with loose demands of the two

principle requirements could employ a standard and therefore low cost reducing valve. The correct selection and deployment in the relevant part of the air system will achieve the lowest cost most energy efficient system.

The penalty for poor regulation characteristics is that the outlet pressure will vary but in the bulk of compressed air applications, inlet pressures are fairly constant so this poses few problems.

The penalty for poor flow characteristics is pressure drop which directly reflects in energy costs. Every regulator suffers from some amount of pressure drop so for good system design this is the more important property to examine.

An important cost saving can be achieved by employing a reducing valve in conjunction with double acting cylinders where a reduced pressure can often be used advantageously on the non-working return stroke and cost savings as high as 30% can be achieved. This can be very important on multi-cylinder installations.

A point common to all pressure regulators is that in order to work constantly and repeatably within their design limits they will require a supply pressure at least 1 bar higher than the required outlet pressure. They will work with a lower differential but performance can be impaired.

TYPES OF REGULATOR

Although Norgren produces a vast array of regulators they can be broadly broken into 4 types:-

- General Purpose
- Pilot Operated
- Precision
- Special Purpose

Most general purpose regulators are of the diaphragm type (figure 22). In general these are more sensitive than piston type regulators which tend to have better flow capacity for a given size. In the majority of compressed air systems response, rather than compactness for a given pipe size is the major requirement, hence diaphragm type regulators are most common.

Regulators can be relieving or non-relieving. The relieving feature allows for the system (outlet) pressure to adjust from a higher level to a lower one without actuating downstream equipment (this is done by having a vent hole through the diaphragm to atmosphere). Generally this relief hole is very small in relation to the regulator main ports so no more than a bleed flow can be achieved and this should not be considered a full relief or even safety relief device.

Non-relieving versions do not have a connection from the downstream system to atmosphere and so can only be adjusted from a higher desired or achieved outlet pressure to a lower one by cycling downstream equipment or using a 3/2 shut-off valve to expel excess air from the downstream system.

Figure 22. GENERAL PURPOSE REGULATOR

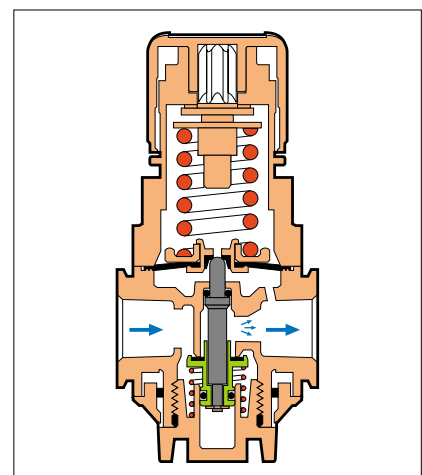

Pilot operated regulators are those which do not have a direct mechanical means of adjusting the outlet pressure. This eliminates leverage problems in achieving high (16 bar plus) pressures in large pipe size units. The outlet pressure is controlled by means of an air pressure signal (Figure 23) which is normally produced by a precision regulator. This allows for example a pilot operated regulator to be remotely situated in the large distribution mains normally in a building's roof, but be adjusted to give the desired output pressure from shop floor level. For the majority of pilot operated applications it is best to take the system or outlet pressure reading from the pilot operated (often called a slave or main) regulator itself or the distribution system as the pilot regulator's outlet pressure is generally not the same.

Pilot operated regulators also give better performance by eliminating the control spring and usually have a large diaphragm area compared to valve area which also improves the accuracy of pressure control in response to small pressure changes.

Another level of control accuracy can be achieved by employing a feedback pilot regulator. This device senses the outlet pressure in the system and a piped connection feeds this signal back to the pilot

regulator which compares it to the desired outlet signal and 'compensates' by increasing the outlet pressure if the feedback signal is too low, or decreases if the signal is too high. This type of control is usually employed where a large steady air flow to a continuous process is required.

Precision regulators (or controllers) are normally used for instrumentation applications where exact repeatability and freedom from outlet pressure setting drift over short or long term operation is necessary. These regulators normally have a small outlet flow range, but exhibit superior flow and regulation characteristics. Their ability to achieve the ideal of these characteristics over flow and pressure ranges is reflected in their size and price.

Generally most precision regulators employ a special arrangement to allow a constant bleed of air to escape to atmosphere. Although this is a cost to system as a whole, being a loss of air, it is the price which must be paid in order to achieve the very fast response to the applications demands needed to keep the system pressure as constant as possible. The best types of precision regulators also employ an integral pilot operation, producing effectively two diaphragms and valves, one small and sensitive the other a slave to ensure that the

Figure 24.
NORGREN MICRO-TROL PRECISION
REGULATOR



overall performance meets the requirements of the particular application.

Another feature of precision regulators is their relief capacity and some have the ability to relieve up to 80/90% of their recommended regulated flow for specialist application such as tensioning belts, paper rolling and balancing. (Figure 24).

Special purpose regulators can cover a whole range of specific demands including meeting exact environmental requirements with special materials, having high relief flows, plunger operation in place of handwheels etc. They can be derivatives of any of the other types of regulators with application specific additions.

Figure 23.
A TYPICAL PILOT OPERATED REGULATOR INSTALLATION.

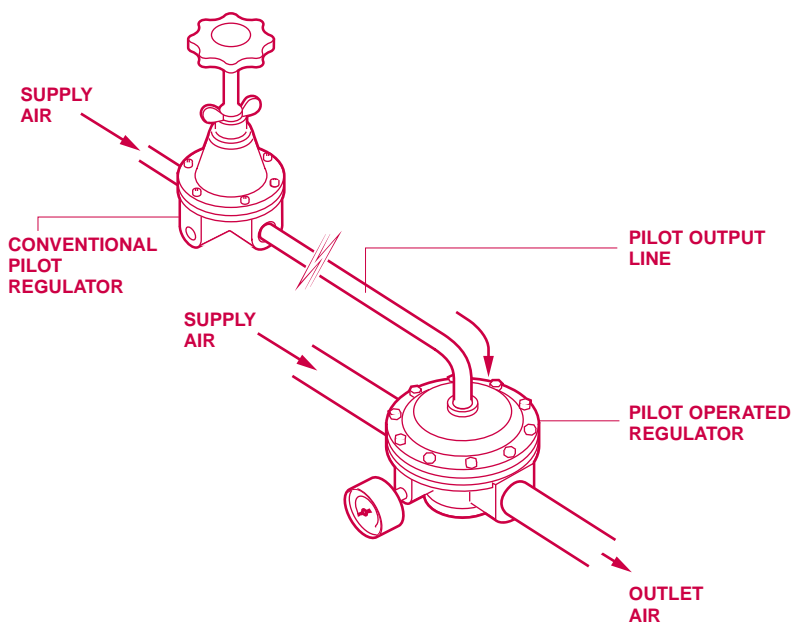

REGULATOR SELECTION

Ensure the regulator chosen exactly fits the performance requirements of the application. A regulator which controls the pressure to a distribution main is usually of the general purpose type or for large volume/flow applications pilot operated.

Decide if the performance requirements need a standard or precision regulator. Then decide if the flow capacity of the regulator is suitable for the pipe size needs (see figure 38) and check with the regulators flow characteristics. Figure 25 shows flow ratings of Norgren General Purpose Regulators . If there is no variation in the inlet pressure to an application then the regulation characteristic of the regulator is unimportant but the flow characteristic will be. If the inlet pressure is exposed to variations then the regulation characteristics

of the chosen regulator must also be considered.

A variety of spring ranges are offered with most regulators. Ideally the regulators should be operated inside the middle third of their range, since at the lower end of their range the spring loses some sensitivity and at the higher end may suffer in linearity. Also low rate springs can help reduce pressure droop, so springs can be selected to best fit the systems requirements.

If a precision regulator is required decide on the level of sensitivity, flow and regulation characteristics and if required relief capacity and temperature sensitivity. Select only a regulator suitable for its application. Correct selection could see a general purpose regulator with ordinary performance characteristics fulfilling what may be considered a precision regulators function without system degradation at a lower installed cost and more cost efficiently.

Figure 25.
GENERAL PURPOSE REGULATOR FLOWS

| Pipe Size | Unit | Flow (dm ³ /s)* |
|-----------|------|----------------------------|
| 1/8" | R07 | 6,5 |
| 1/4" | R72G | 33 |
| 1/2" | R64G | 120 |
| | R74G | 105 |
| 1" | R15 | 180 |

*Flow with 10 bar inlet, 6,3 bar outlet and 1 bar pressure drop.

FILTER/REGULATORS

Filter/regulators both clean the air to the application and control the pressure in one compact unit. For general purpose applications filter/regulators are usually lower cost than two separate units.

Some specialist filter/regulators are available for instrument applications with fine particle removal or even oil removal properties with precision regulator characteristics, as are others with special material compatibility.

Figure 26.
NORGREN FILTER/REGULATOR FLOW CAPABILITIES.

| Pipe Size | Unit | Flow (dm ³ /s)* |
|-----------|------|----------------------------|
| 1/8" | B07 | 6,2 |
| 1/4" | B72G | 38 |
| 1/2" | B64G | 110 |
| 1/2" | B74G | 100 |
| 1" | B15 | 230 |

*Flow with 10 bar inlet, 6,3 bar outlet and 1 bar pressure drop.

Figure 27.
GENERAL PURPOSE FILTER/REGULATOR

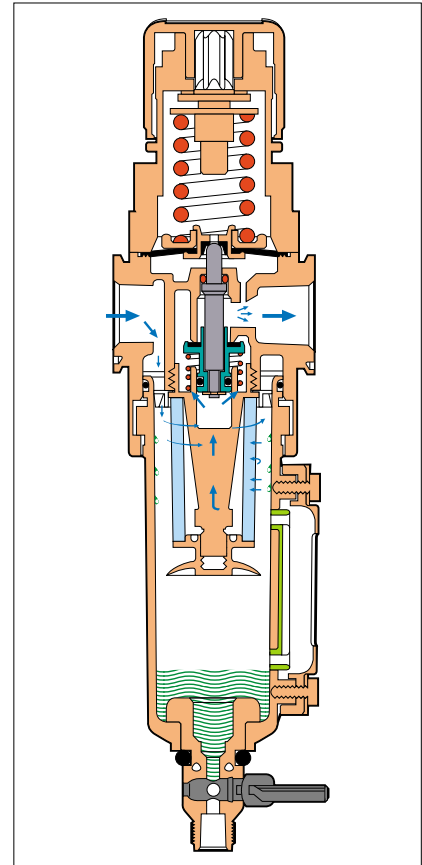

Figure 28.
ALUMINIUM INSTRUMENT FILTER/REGULATOR



LUBRICATION

The next important step in processing compressed air is that of introducing into the air a suitable amount of lubricant, usually oil to enable the operating equipment to perform to its requirements efficiently without excessive resistance or wear. Excessive resistance to motion will result in extra power consumption and excessive wear will result in shortened equipment life. Both result in extra cost.

There are two basic type of lubricator in general use, aerosol and injection pump.

The most widely used is the aerosol, which was the first type of dependable automatic air line lubrication device, invented by Norgren in 1927.

Aerosol lubricators are available in two main types, Oil-Fog and Micro-Fog. In an Oil-Fog lubricator the fog produced generally has relatively large oil particles and so will only remain airborne for relatively short distances. As a general rule of thumb the maximum distance an Oil-Fog lubricator should be placed from the pneumatic device which it is to service is 9 metres. Large particles are more strongly affected by gravity and so Oil-Fog lubricators should not be used in attempting to lubricate a device at a higher level than the lubricator.

The Micro-Fog lubricator uses a special fog generator to atomise only a fraction of the oil.

Because the airborne fog is now made up of only light particles, less than about 2 microns in size, gravity does not have the same effect upon it and so this fog can travel not only "up-hill" but also for long distances and through more complex feed lines without wetting out in the pipe. Micro-Fog can also ensure proportionate distribution through multiple lubrication outlets, ideal for multiple valve control circuits.

A comparison of these two types of lubricators can lead to a simple division of them as being high delivery (Oil-Fog) or low delivery types (Micro-Fog). All of the droplets of oil shown in the Oil-Fog sight dome will be delivered into the system and for the Micro-Fog only about 5 to 10% of the droplets witnessed will be delivered. The Micro-Fog can therefore be used in applica-

tions where only very small amounts of lubricant are required, possibly over large areas. By adjustment of the drip rate higher oil delivery can be achieved to match that of an Oil-Fog lubricator at normal usage rates.

The Micro-Fog principle has made possible the application of aerosol lubrication to general machine lubrication such as bearings, gears, chains etc.

Both Oil-Fog and Micro-Fog lubricators include a non-return valve in the syphon tube to ensure immediate lubrication as soon as the air is turned on. However for some rapidly cycling duties or systems with small stroke cylinders it is sometimes not possible to lubricate correctly with conventional lubricators. For such applications system modifications such as quick exhaust valves must be employed or a bi-directional lubricator suitably located can overcome such problems.

The second type of lubricator, the injection oil-pump is a positive displacement device. Because of its nature it cannot continuously deliver lubricant but has particular applications in multi-spindle nut runners where conventional lubricators will split air flows according to passageway geometry. The injection pump will deliver the same amount of lubricant to the application point every time it is cycled. This type of lubricator is often used on conveyor chains where their application will overcome problems of incorrectly located or adjusted conventional lubricators.

Several such injectors can be manifolded together to lubricate at several different points, but at the same frequency.

Whichever type of lubricator is employed it is important to remember that all lubricators are total loss systems in that the dispensed lubricant will reach its 'bearing' surface and be broken down into smaller particles and 'lost' as the system is cycled.

The amount of oil which should be delivered to a pneumatic system to provide sufficient lubrication is difficult to determine as all systems will be different. Pneumatic devices in a system may require different amounts of lubricant and so equipment manufacturers recommendations should always be followed, where they exist.

For a general guide for most pneumatic systems an oil output density of

Figure 29.
OIL-FOG LUBRICATOR

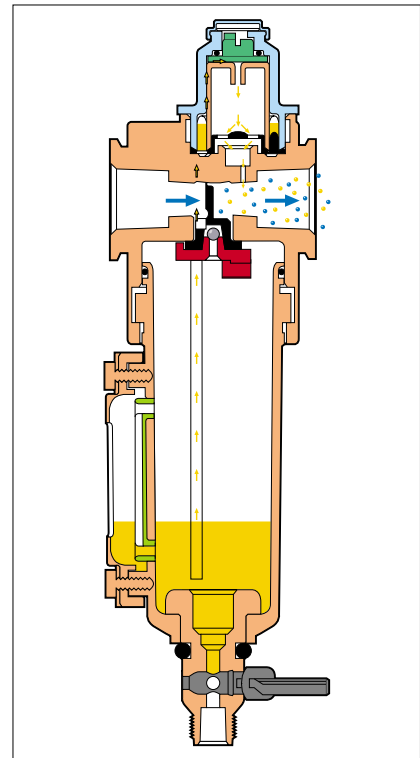

60 mg/m³ is a good basic starting point. From regular inspection and servicing the optimum setting may be found by increasing or decreasing the amount delivered.

FILLING LUBRICATOR BOWLS

With all lubricators eventually the bowl or reservoir will need filling. Most Oil-Fog lubricators have a check valve fitted to allow them to be refilled whilst in use. Most Micro-Fog lubricators can be fitted with a quick fill nipple and so be topped up with lubricant, supplied at a pressure of approximately 1 bar above that within the bowl.

Remote fill devices also exist which can do this automatically. Such devices can be used to supply several bowls or reservoirs from one central position.

Another way to reduce the scheduled task of refilling lubricators or to ensure critical operations never 'run dry' is to employ a liquid level switch. Such devices are normally float operated switches which can give an electrical signal on low or high liquid level. Such signals can then be built into a control system to fill or stop filling or give warning alarms.

Figure 30.
MICRO-FOG LUBRICATOR

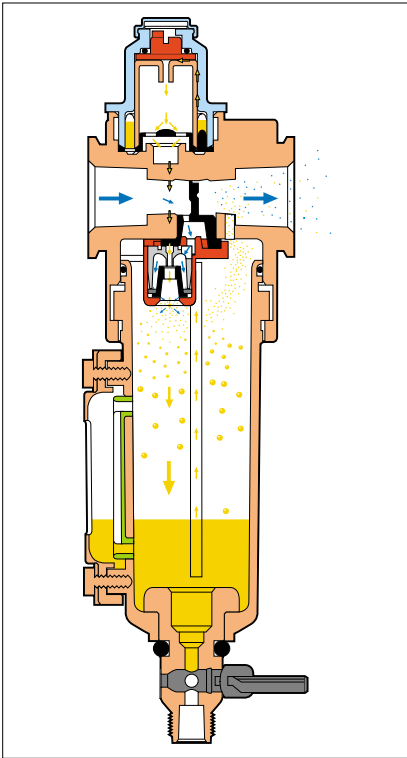

Although a high level signal may at first seem strange remember that overfilling will not only prevent the lubricator from performing its function of producing an air/oil mix of fog, but will distribute bulk lubricant into the pneumatic system, flooding it.

LUBRICATOR SELECTION

Determine which parts of the system require lubrication (some distribution lines will be to oil free areas such as paint spraying or breathing air applications).

Determine what type of lubrication is required for each part of the system. Slow moving heavy cylinders need high delivery so chose an Oil-Fog type lubricator. Long runs of pipe in multi-valve circuits require a Micro-Fog (or several Oil-Fog) lubricators to lubricate effectively. High speed tools are better served by a Micro-Fog, as are tips of cutting tools.

All lubricators are a source of pressure drop and therefore energy loss, so although Micro-Fogs may be positioned almost anywhere in a system select and place them as conveniently close to the

application as possible. Always select lubricators and locate them where different levels of lubrication are required, never attempt to fit one lubricator to supply a whole distribution system as differing parts will then be over lubricated, whilst others are under lubricated.

Ensure that only special purpose Micro-Fog lubricators are used for bearing lubrication as other types are not suitable.

Check that the lubricator chosen has sufficient flow capacity without excessive pressure drop for the pipe line size being used (see figure 31 and individual lubricator performance graphs).

Figure 31. LUBRICATOR FLOW RATES

| Pipe Size | Unit | Flow (dm ³ /s)* |
|-----------|---------|----------------------------|
| 1/8" | L07 | 5 |
| 1/4" | L72 | 24 |
| 1/2" | L64/L74 | 72 |
| 1" | L15 | 175 |

*Flow at 6,3 bar and 0,5 bar pressure drop.

Since lubricators require a minimum pressure drop to operate which is normally related to a flow, ensure that this minimum flow condition is met or there will be no oil output. It is important to note that leaks from compressed air systems are a source of energy loss and also such leaks are effectively a constant flow through the system. If a lubricator with a very low start point is used then even a small leakage, if in excess of the start point will cause it to drip and supply oil to the system. This is often the cause of oil flooding during periods of shut-down, especially over weekends.

Where continual usage exists select a lubricator with sufficient reservoir capacity. For units in 1/2" pipe size and above, several reservoir capacities are usually available. Where this is not possible because of space or usage rate utilise remote fill devices or liquid level switches to auxiliary systems.

Where very high flows are encountered use a fixed venturi type lubricator. Unlike standard types this does not automatically adjust to give a constant air/oil density, so the flow requirement needs to be essentially constant. This type of device will then not produce excessive pressure drops

associated with high flows and so be more energy efficient.

For exceptionally high flow rates small amounts of lubricant (especially for anti-freeze usage) can be injected by small lubricators into large distribution mains of 1 to 2" and above, where a full bore lubricator would be expensive in both cost and pressure drop.

PROTECTING SYSTEMS, PERSONNEL AND THE ENVIRONMENT

Safety in the workplace is essential and is emphasised via the Machinery Directive, the Pressure Systems legislation and the Provision and Use of Work Equipment Regulations (PUWER).

The following section can help machine designers and others using pneumatics by illustrating those air line products which, when correctly applied, can be used to ensure safe pneumatic systems.

In it we have cross referenced relevant documents. Norgren strongly recommend that all who are involved with machine and system design should become familiar with these and other relevant safety documents.

OVERPRESSURE PROTECTION

The components in pneumatic systems will often have a pressure rating lower than that generated at the compressor and pressure regulators are used to reduce this pressure to safe efficient levels. In the event of a fault the components can be exposed to excess pressures leading to mis-function or in extremes failure of the pressure containing envelope.

To protect against this excessive over pressure situation several solutions can be employed the most common being a relief valve. Selecting a relief valve is not a simple process, and detailed consideration of the system or element of the system is required.

In general all pneumatic components and equipment will have a Safe Working Pressure (SWP) and over pressure limit of 10%. The designer of the pneumatic system can use regulators to run the system at pressures below the SWP and use the 10% safety factor to be the limit of over pressure that the system can experience with the relief valve in operation.

A relief valve is defined as a device with its outlet so connected to a pressure system to enable the system pressure to be held at a constant level. This constant level would then be at or below the stated SWP + 10% over pressure allowance.

Relief valves need to be set to only

operate when the regulated pressure is exceeded and so need to be set higher than the regulator. There will be a tolerance on the relief valve setting and on the regulators outlet setting, depending on its flow and regulation characteristics. A common problem is a relief setting too close to the system operating pressure. The consequence of this is to have the relief valve operating and venting air during normal system operation, which is an expensive waste of air.

Once the relief valve setting pressure and acceptable level of over pressure are checked the flow capacity of the relief device and that of the system can be considered. The relief device must be able to match or exceed the amount of flow through the part of the system being protected without the system pressure rising above the acceptable over pressure level.

Several methods can be used to achieve this:-

The relief device has a flow capacity in excess of the compressors free air delivery capacity - in systems where no receiver exists - i.e. flow out of system is greater than flow in.

The relief device has a capacity in excess of the flow through the smallest flow passageway upstream of the equipment being protected. Tables of orifice flow exist to determine the flow at different pressures through differing sizes of orifice. The smallest bore is acting as a restriction to the flow into the downstream system and unless the upstream pressure can be increased the flow will be choked through this area and therefore limited. This is important since a mains distribution system can be of very large volume with pipes of large bore and compressors of high capacity, but the device being protected could be fed by 1/8" nominal bore tubing. So a small low cost device only is required and not one large enough to cope with the full system capacity.

In areas where no such flow restriction exists, one should be created in order to reduce the cost of the relief valve to be employed, ensuring of course that the restriction does not cause excessive pressure drop in the course of normal operation.

Legislation Reference:

BS EN 983 5.1.2

TYPES OF RELIEF VALVES

Several types of relief valves exist to achieve different levels of performance with respect to the flow capacity and over pressure limitations. The most common is the 'pop' type, followed by the diaphragm type. For better performance use pilot operated valves with the integral pilot operated type being the most compact and cost effective (figure 32).

An "in-line" type of relief device has relief port at 90° to the direction of flow and in normal operation flow passes through the body of the device, without interfering with normal upstream operation. A common use of this type of device is with machine builders, where all the control equipment/protection devices are in one discrete position, aiding both installation and scheduled servicing.

The in-line device differs from the pop or diaphragm type of relief valves which are connected into the system on a tee-piece. Flow through these devices only occurs when in operation and air vents to atmosphere.

In both cases the exhaust flow can be piped away to an area where the noise and flow will not cause disruption or harm to the environment or the operators. Exhaust silencers may be required to reduce noise levels in high flow exhaust applications where piping away to less sensitive areas is not possible.

Figure 32.
INTERNAL PILOT RELIEF VALVE

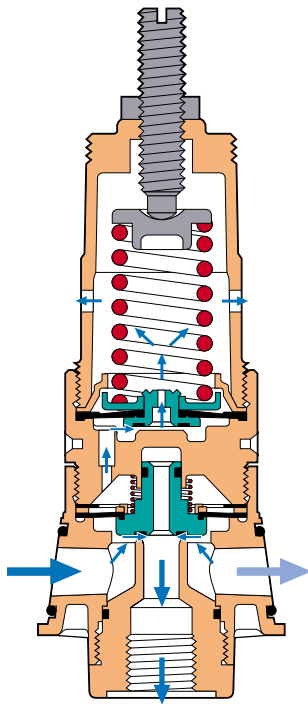

Figure 33.
SOFT START/DUMP VALVE



SOFT START/DUMP VALVES

The next form of protection is that associated with the moving parts of the system, where the parts themselves can need protection against excessive wear due to loading on start up or there is danger to personnel from sudden movement of the parts.

Here the use of "soft start" ("slow start") valves is desirable. The normal operation is to allow air to pass to a pneumatic system or device in a gradual manner, where the rate of pressure build-up can be controlled by adjustment of the valve. The valve design is generally an internal poppet valve which is spring operated and when the gradual pressure build-up produces a force in excess of that holding the poppet closed, the poppet moves to the open position allowing flow to proceed through the normal flow passageways. The level at which the poppet operates is called the snap point and for most devices this snap point will be in the range of 40 to 70% of full line pressure.

Because pressure build up in any system is dependant upon the system volume it is important to locate these devices close to the piece of equipment they are to protect. Fitting of a larger valve to a complete distribution system will generally mean the system will take many minutes to fully pressurise.

It is extremely common to couple the slow start valve with a dump or exhaust function valve within one body, for compactness.

The function of the 'dump' valve is to quickly exhaust the pressure from the downstream system. The valve can have solenoid or air pilot operators and often a manual override or emergency dump function.

Legislation Reference:
BS EN 983 5.1.4

EXHAUST AIR

Exhaust air needs to be treated correctly to reduce the effects of noise, oil mist and to minimise danger to personnel.

Where a dump valve is employed, large volumes of air can be released at high speed which will produce high noise levels. Simple silencers made of porous materials are often able to deal with this. In more demanding high velocity cycling applications a heavy duty silencer may be needed.

Silencers are normally rated for their noise reduction and associated back pressure so the choice should be dependent upon the duty required of the device to ensure the most cost efficient silencer is utilised.

The next major pollutant is oil. All pneumatic lubrication systems are total loss systems, the lubricant goes into the system, gets degraded in its function and is carried along with impurities and dirt to the atmospheric exhaust.

In well maintained and correctly lubricated systems of a general engineering nature the amount of exhausting oil is very small and will disperse without generally affecting the working environment adversely. However incorrectly lubricated systems or those which require high levels of lubrication for heavy duty applications can expel high levels of oil into the atmosphere on their

Figure 34.
COALESCING SILENCER



exhaust cycle. In such instances use of a coalescing exhaust silencer should be considered. The action of this device is exactly as those for oil removal filters which cause the small oil droplets to merge together into large droplets which fall into a container for removal. (See figure 34.) In the course of this process the porous material employed also reduces the noise level of the exhaust air.

Since these devices are on the exhaust side of the pneumatic system they are exposed to sudden shock loading, which means their oil removal capabilities are not as good as those employed in coalescing filters. A good exhaust coalescing silencer will however give figures of typically 2 ppm under average usage conditions.

PROTECTION DEVICE SELECTION

(i) Decide which parts of the system cannot withstand the maximum pressure which can be developed in the distribution system (or compressor).

Determine which type of relief valve is required to control this air pressure most effectively with consideration of failure flow through that part of the system. Consider using a restrictor (orifice) without producing excessive pressure losses in the normal operation of that part of the system.

For very large flows consider a pilot operated regulator as a dump valve.

For machines consider an in-line device to build-up one complete integral modular preparation assembly for ease of piping, location and servicing.

(ii) Decide upon which parts of the system can suffer from problems on initial start up, or resetting where excessive initial speeds can lead to wear problems or entrapment, or where an emergency stop/dump function is required.

Employ one soft start/dump valve for each section of the system operated in this way. The larger the system the longer the dump or emergency stop function will take to fully empty the system.

Locate soft start/dump valves in the FRL assembly at the downstream end to prevent high back flows through the lubricator.

(iii) Where large volumes of air are to be exhausted consider fitting a silencer if the air cannot be piped away to a convenient position.

Where rapid cycling of exhaust is present fit a heavy duty silencer.

Where the exhaust air can be heavily laden with lubricant, usually from equipment requiring high levels of lubrication fit a coalescing exhaust silencer.

OTHER PRODUCTS FOR SAFE SYSTEMS

Other air line products that can help create safe pneumatic systems -

Preset pressure regulators - where unauthorised adjustment of the set pressure can be injurious to personnel.

Guidance Document: HS (G) 39

Lockable shut-off valves - ensure that a 'safe to work' procedure can be adopted without jeopardy from the unauthorised re-application of pressure.

Legislation: BS EN 983 5.1.6

Guidance Document HS (G) 39

Tamper resistant kits - can be fitted to pressure regulators, filter/regulators, relief valves and lubricators to ensure that flow, pressure and other settings are secured against unauthorised adjustment.

Legislation Reference:

BS EN 983 5.1.9

**NORGREN
AIR PREPARATION
PRODUCT OVERVIEW**



UNRIVALLED PRODUCT RANGE

Norgren, the world leader in air preparation offers an unrivalled range of products to enable you to produce clean compressed air and use it economically and safely.

Whatever your need from the simplest factory installation to a complex medical application, Norgren has the right air preparation equipment for you.

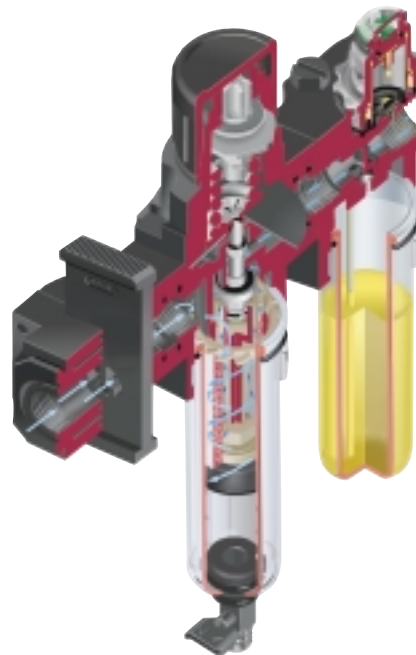

Figure 35.
EXCELON SYSTEM

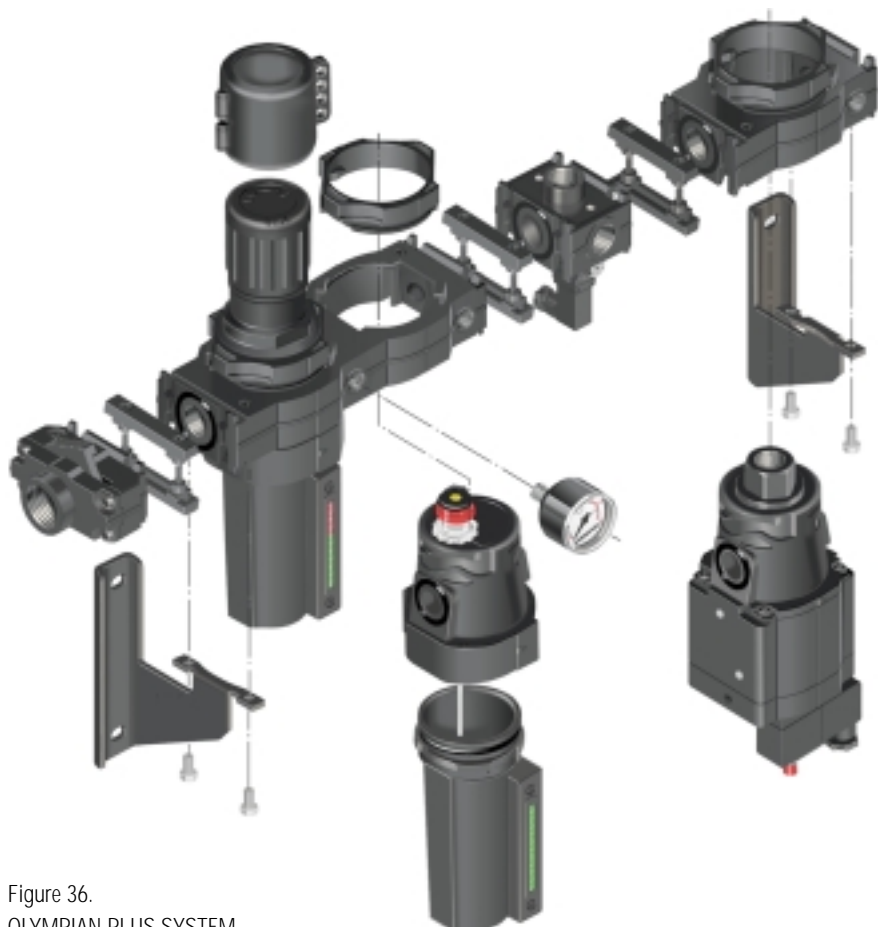

Figure 36.
OLYMPIAN PLUS SYSTEM

NORGREN AIR PREPARATION PRODUCT OVERVIEW

These pages show the main product families, together with just a few of the more specialised standard products. In addition we produce hundreds of products to customers specifications, utilising the vast experience Norgren has accumulated over the past 70 years.

All the main ranges include :-

General Purpose Filters

High Efficiency Filters

Vapour Removal Filters

General Purpose Regulators

Filter/Regulators

Oil-Fog and Micro-Fog Lubricators

Soft Start/Dump Valves

Shut-Off Valves

Relief valves

These are supported by a wide choice of mounting methods and accessories

Porting Blocks

Pressure Switches

Level Controls

Service Indicators

Manifold Blocks

OLYMPIAN PLUS



Olympian Plus is the new generation FRL system, which sets new standards for ease of use and flexibility. The unique plug in feature allows quick installation or removal of units with a simple quarter turn of the clamp ring. The easily connected yoke systems allows speedy assembly of combination units.

Packed with features to make field maintenance easy and convenient Olympian Plus is ideal for industrial installations. Equally the wide range of system accessories mean it offers the OEM user a highly flexible solution.

Olympian Plus is available in basic 1/2 inch , with optional 1/4, 3/8 and 3/4 porting.

OLYMPIAN 15 SERIES

The 15 Series is the basic 1" version of the Olympian system. Available in 3/4 through 1 1/2 inch ports it offers a flexible solution for larger machines and high volume industrial use.

EXCELON



Excelon is a completely new air preparation system from Norgren. Although direct ported, thanks to a patented Quikclamp connection system, Excelon can be used where both stand alone units or modular assemblies are required.

It offers exceptional performance in a compact well styled unit. It is ideal for OEM's offering a flexible modular system with useful accessories such as pressure switches and manifold blocks. The quick release bayonet bowl, high visibility liquid level indicator and easy to operate patented Quikdrain are just a few of the features designed with ease of maintenance in mind.

There are two sizes in the Excelon range.

EXCELON 72 is basic 1/4 (with optional overporting to 3/8). However there is nothing basic about its performance, which is actually better than many competitors 3/8 products.

EXCELON 74 is a 1/2 inch range (optional 3/8 and 3/4).

PORTED UNITS



The ported products have no modular connection system, and are generally used as stand alone units. They cover a wide range of basic port sizes from 1/8" (07 Series) through 2" (18 Series).

07 SERIES

The miniature range offers good performance units for smaller flow requirements. Here regulators are the most common product and in addition to the catalogued units Norgren offers a vast array of options. Units are available in a range of body materials, with internal components chosen to deliver the specific performance characteristics requested by the customer.

11 SERIES

A basic 3/8" size the 11 Series is also offered with 1/4" and in some cases 1/2" ports. These are well proven reliable units often used as an alternative to a true 1/2" product, where the flow requirements are not high.

18 SERIES

The 18 Series is a basic 2 inch range designed for factory air mains or high flow OEM applications such as shot blasting or textile machines.

PRECISION REGULATORS



Norgren has several different precision regulators, each offering the designer a particular combination of performance characteristics from which to select the best unit for the application. Many specials are produced in addition to the catalogued options.

11-818

Compact, high precision regulators for air gauging, laboratory use and precise pilot control.

11 400

For high accuracy pilot control of large regulators and relief valves.

R24 MICRO TROL

Exceptionally high flow with excellent relief performance.

R38

Instrument regulator produced in aluminium or stainless steel.

R27

High precision regulators featuring a wide choice of operators.

SPECIALISED PRODUCTS



STAINLESS STEEL

Norgren produces units which meet NACE requirements for use offshore and in harsh process environments. The 38 Series regulator and filter/regulator are 1/4 NPT units offering high flow with good precision. The 22 Series filter, regulator and lubricator are basic 1/2" and for lower flow applications there is the 1/4" 05 Series.

WATER REGULATORS

Regulators with plastic or brass bodies suitable for general or potable water duty.

RELIEF VALVES

In addition to the relief valves which are part of the main FRL families Norgren has several specialised units including Pop Type and the air piloted 40AC.

ELECTRONIC REGULATORS

Norgren can offer fully programmable electronic regulators for use with any standard industrial PLC. The R26 Pneu-Stat electronic regulator gives stable output over long periods and is ideal for closed loop pressure control in applications such as welding machines which require many different pressure settings.

GLOSSARY

After Cooler:

A heat exchanger mounted on a compressor outlet to extract the heat of compression.

Ambient:

The conditions, usually temperature, in the vicinity of the equipment under normal working conditions.

Back Pressure Regulator:

A device connected to a system in such a way that the system pressure is held effectively constant by control of the outlet flow to atmosphere.

Check Valve:

A device which allows flow in one direction only.

Coalescing:

The action causing small particles to unite to form larger particles.

Deliquescent Dryer:

A dryer using material which absorbs water vapour to such an extent that the material ultimately dissolves into the water it absorbs.

Desiccant:

An adsorbing material used in some dryers. Many such dryers are regenerative in that they use some of their energy to dry the material making it suitable for reuse.

Drip Leg Drain:

A device at the bottom of a down leg from a distribution main or a system low spot to remove condensed water from the system. Such devices are normally fitted with automatic drain valves.

Dump Valve:

A valve which is connected to atmosphere in such a way as to rapidly exhaust the system pressure.

Emulsion:

A mixture of oil and water.

Failure Flow:

The maximum flow through a device at a given pressure with the valve open to maximum extent.

Flow Characteristics:

A characteristic of a pressure regulator which shows the variation of outlet pressure with varying outlet flow rates at a constant supply pressure.

Free Air:

Air flow measure in dm³/s at STP (1 013mbar and 21°C) (ISO R554). All air flows are converted to this to make system sizing easier.

Initial Droop:

The amount of pressure drop incurred by a pressure regulator in going from a flow (static) condition to a small flow (dynamic) condition.

Micro-Fog:

A suspension of light oil fractions in air, typically less than 2 µm in size which can travel long distances, through complex passageways.

Micron (micrometre):

A measurement of size on millionth of a metre (symbol µm).

Oil-Fog:

A suspension of oil fractions in air, heavier and larger than Micro-Fog, suitable for heavy duty lubrication.

Pilot Operated Regulator:

A regulator which has its outlet pressure controlled by the outlet pressure of another (piloting) pressure regulator, and not by an integral adjustable spring load as with standard pressure regulators.

Porting Block:

A modular device for allowing several air take-off from a main air flow control set.

Pressure Drop (Droop):

The amount of pressure loss incurred by the flow of air through a device.

Pressure Reducing Valve/Pressure Regulator:

A device which is used to lower air pressure in a pneumatic system to a desired working level.

Regulation Characteristic:

A characteristic of a pressure regulator which shows the variation of outlet pressure with varying inlet pressure at a constant flow rate.

Relative Humidity:

The ratio of the actual amount of water vapour present in a given volume of air, to the amount of water vapour necessary to saturate the same volume of air at the same temperature.

Soft Start Valve:

A device which on initial pressurisation of a system allows the pressure to build up slowly to a pre-determined intermediate level before allowing a step-up to full line pressure to be achieved.

REFERENCE TABLES

Figure 37.

FRICION LOSS IN PIPE FITTINGS IN TERMS OF EQUIVALENT METRES OF STRAIGHT PIPE.

| | 8 mm | 10 mm | 15 mm | 20 mm | 25 mm | 32 mm | 40 mm | 50 mm |
|------------------------|------|-------|-------|-------|-------|-------|-------|-------|
| Tee (straight through) | 0,15 | 0,15 | 0,21 | 0,34 | 0,46 | 0,55 | 0,67 | 0,92 |
| Tee (side outlet) | 0,76 | 0,76 | 1,01 | 1,28 | 1,62 | 2,14 | 2,47 | 3,18 |
| 90° elbow | 0,43 | 0,43 | 0,52 | 0,64 | 0,79 | 1,07 | 1,25 | 1,59 |
| 45° Elbow | 0,15 | 0,15 | 0,24 | 0,30 | 0,38 | 0,49 | 0,58 | 0,73 |
| Ball valve* | 0,01 | 0,03 | 0,09 | 0,12 | 0,15 | 0,22 | — | — |

* Self exhausting – full open

Figure 38.

MAXIMUM RECOMMENDED FLOW * THROUGH ISO 65 MEDIUM SERIES STEEL PIPE.

| Applied Gauge Pressure bar | Nominal Standard Pipe Size (Nominal Bore) – mm | | | | | | | | | | |
|----------------------------|--|-----|------|------|-----|-----|-------|-------|-----|-------|-------|
| | 6 | 8 | 10 | 15 | 20 | 25 | 32 | 40 | 50 | 65 | 80 |
| | Approximate Pipe Connection – inch | | | | | | | | | | |
| | 1/8 | 1/4 | 3/8 | 1/2 | 3/4 | 1 | 1 1/4 | 1 1/2 | 2 | 2 1/2 | 3 |
| 0,4 | 0,3 | 0,6 | 1,4 | 2,6 | 4 | 7 | 15 | 25 | 45 | 69 | 120 |
| 1,0 | 0,5 | 1,2 | 2,8 | 4,9 | 7 | 14 | 28 | 45 | 80 | 130 | 230 |
| 1,6 | 0,8 | 1,7 | 3,8 | 7,1 | 11 | 20 | 40 | 60 | 120 | 185 | 330 |
| 2,5 | 1,1 | 2,5 | 5,5 | 10,2 | 15 | 28 | 57 | 85 | 170 | 265 | 470 |
| 4,0 | 1,7 | 3,7 | 8,3 | 15,4 | 23 | 44 | 89 | 135 | 260 | 410 | 725 |
| 6,3 | 2,5 | 5,7 | 12,6 | 23,4 | 35 | 65 | 133 | 200 | 390 | 620 | 1 085 |
| 8,0 | 3,1 | 7,1 | 15,8 | 29,3 | 44 | 83 | 168 | 255 | 490 | 780 | 1 375 |
| 10,0 | 3,9 | 8,8 | 19,5 | 36,2 | 54 | 102 | 208 | 315 | 605 | 965 | 1 695 |

*Air flow rates in dm³/s free air at standard atmospheric pressure of 1 013 mbar.

General notes

The flow values are based on a pressure drop (DP) as follows:

10% of applied pressure per 30 metres of pipe 6 – 15 mm nominal bore inclusive

5% of applied pressure per 30 metres of pipe 20 – 80 mm nominal bore inclusive

Figure 39.

DRYER COMPARISON

| Dryer Type | Pressure Dew Point | Atmospheric Dew Point | Drying Media Replacement | Power Consumption | Initial Cost | Pre Filters | After Filters | Maintenance Cost |
|------------------------|--------------------|-----------------------|------------------------------|-------------------------|--------------|--------------------------------|---------------|--------------------------------------|
| Refrigerated | 2°C | -23°C | Nil | For refrigeration motor | Medium | General purpose and coalescing | None | Regular maintenance of refrigeration |
| Regenerative Desiccant | -40°C | -57°C | Infrequent | For drying desiccant | High | General purpose and coalescing | Coalescing | Small |
| Deliquescent | 10°C | -15°C | Regularly, minimum 6 monthly | Nil | Low | General purpose and coalescing | Coalescing | Recharging container |



Certificate No. FM 20822



Actuators



Valves



Fittings



Air Line

Norgren is a leading world manufacturer and supplier of pneumatic solutions, offering a comprehensive range of pneumatic control and automation components via a global sales and service network which covers 70 countries worldwide. The company is a principal member of the diverse and internationally successful £1 billion IMI Group



○ Sales centres

For further details, contact your local Technical Sales Centre on 0345 662266

IMI Norgren Limited
PO Box 22, Eastern Avenue, Lichfield, Staffordshire, WS13 6SB
<http://www.norgren.com>

'Olympian', 'Excelon', 'Quikclomp', 'Micro-Fog', 'Ultrair', 'Purair', the Roundel, 'Norgren' and 'IMI' are registered trade marks.
© IMI Norgren Limited 1997

Due to our policy of continued development, Norgren reserve the right to change specifications without prior notice.

IMI
a subsidiary of IMI plc

