

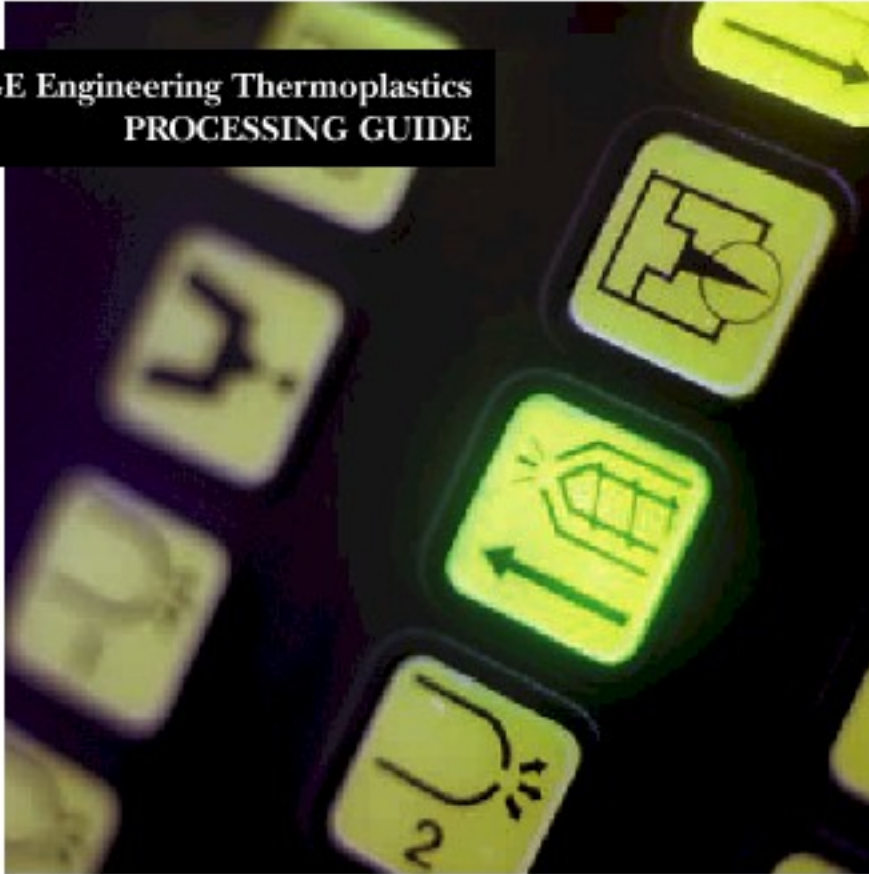

## Noryl\* PPO Processing Guide

---

GE Engineering Thermoplastics  
**PROCESSING GUIDE**



NORYL resin is a modified PPE/PS blend that offers eco-friendly, market-tailored performance, optimized processing and enhanced productivity in applications ranging from computers and business equipment to electrical/electronic appliances to telecommunications. There's a broad choice of injection-moldable, extrudable and foamable grades, plus automotive-specific grades and special high modulus grades able to replace stamped steel and die-cast metal in tight tolerance, functional assemblies. Its halogen-free flame retardancy characteristics make it particularly suitable for use in public building applications.

# Contents

---

## Materials

Materials

## Mold Design Specifics

Mold Temperature Control

## Equipment

Machine Selection

Barrel Selection and Screw Design Considerations

## Molding Conditions

Drying Parameters

Melt Temperature

Mold temperature

Screw Speed

Back Pressure

Shot Size

Ram Speed

Injection Pressure

Cushion

Cycle Time

Effect of Wall Thickness on Flow Length

Mold Release

Downtime

Purging

Regrind

---

# Materials



## NORYL Modified PPO Resin

NORYL® modified PPO resin is a line of engineering thermoplastic resins based on polyphenylene ether (sometimes referred to as polyphenylene oxide or PPO®). PPO, a high-heat amorphous polymer, forms a miscible, single-phase blend with polystyrene. This technology, in combination with other additives, provides a family of resins offering a wide range of physical and thermo-mechanical properties.

Offering high heat resistance, mechanical properties, and flame resistance, NORYL resins combine design flexibility and a broad range of processing options. The low moisture absorption and hydrolytic stability of these resins – among the lowest of any engineering thermoplastic – permit good electrical performance over a wide range of humidity and temperature conditions. With heat deflection temperatures that extend to 380°F (193°C), coupled with impact strength and broad UL recognition, NORYL resins offer a design alternative for applications that must perform under load at elevated temperatures.

NORYL resins are available in glass fiber reinforced or mineral filled grades for added strength and stiffness. High flow grades provide improved productivity and high modulus grades offer tight tolerance molding for high performance components such as computer bases.

| Property                    | Characteristic  | Typical Designations   |
|-----------------------------|---|--|
| Unfilled Flame Resistant    | Standard flame resistant grades offering a range of thermal and mechanical properties.  | N190X, N225X, N300X, SE1X, SE100X, PX9406, PC180X  |
| Reinforced                  | A series of grades containing glass and/or mineral reinforcement for stiffness or strength.   | Non-flame Resistant: GFN1, GFN2, GFN3, Flame Resistant: SE1GFN1, SE1GFN2, SE1GFN3, HS1000X, HS2000X, HMC202M |
| High Heat and Mechanical    | A series of non-flame resistant grades offering a range of thermal and mechanical properties for general purpose and automotive applications. | PXW20, PX0844, PX0888, PX1265, PX1391,731  |
| High Heat Impact Resistance | A series of unfilled and reinforced resin grades suitable for automotive interiors and instrument panels.                                     | EM series  |

The following pages contain additional information on mold design and/or processing specific to NORYL resin. Additional information on these subjects is included in Chapter 1 (Mold Design) and Chapter 2 (Processing) of the GE Plastics Processing Guide.

## Mold Temperature Control



The usual range for processing unreinforced NORYL grades is from 150 to 200°F (66 to 93°C). Operating molds in this temperature range can also be used to improve flow, knitline strength and surface finish.

Typical molding temperatures for NORYL resins are presented in Table 8-3 .

| Processing Parameters | Units     | N190X<br>PC180X<br>SE100X |          | EM7100<br>HS1000X |          | PXW20<br>N225X |          | EM6100<br>EM6100F<br>EM6101 |          | EM7301F<br>EM7304F<br>HMC3008A |          |
|-----------------------|-----------|---------------------------|----------|-------------------|----------|----------------|----------|-----------------------------|----------|--------------------------------|----------|
|                       |           | (min.)                    | (max.)   | (min.)            | (max.)   | (min.)         | (max.)   | (min.)                      | (max.)   | (min.)                         | (max.)   |
| Drying Temperature    | °F(°C)    | 170(77)                   | 180(82)  | 190(88)           | 200(93)  | 200(93)        | 210(99)  | 200(93)                     | 220(104) | 210(99)                        | 220(104) |
| Drying Time (Normal)  | h         | 3                         | 4        | 3                 | 4        | 3              | 4        | 3                           | 4        | 3                              | 4        |
| Drying Time (Max.)    | h         | –                         | 8        | –                 | 8        | –              | 8        | –                           | 8        | –                              | 8        |
| Maximum Moisture      | %         | –                         | 0.02     | –                 | 0.02     | –              | 0.02     | –                           | 0.02     | –                              | 0.02     |
| Melt Temperature      | °F(°C)    | 480(249)                  | 530(277) | 490(254)          | 540(282) | 500(260)       | 550(288) | 510(266)                    | 560(293) | 520(271)                       | 570(299) |
| Nozzle                | °F(°C)    | 480(249)                  | 530(277) | 490(254)          | 540(282) | 500(260)       | 550(288) | 510(266)                    | 560(293) | 520(271)                       | 570(299) |
| Front Zone            | °F(°C)    | 460(238)                  | 530(277) | 470(243)          | 540(282) | 480(249)       | 550(288) | 490(254)                    | 560(293) | 500(260)                       | 570(299) |
| Middle Zone           | °F(°C)    | 440(227)                  | 520(271) | 450(232)          | 530(277) | 460(238)       | 540(282) | 470(243)                    | 550(288) | 480(249)                       | 560(293) |
| Rear Zone             | °F(°C)    | 420(216)                  | 510(266) | 430(221)          | 520(271) | 440(227)       | 530(277) | 450(232)                    | 540(282) | 460(238)                       | 550(288) |
| Mold Temperature      | °F(°C)    | 130(54)                   | 170(77)  | 150(66)           | 190(88)  | 160(71)        | 200(93)  | 150(66)                     | 200(93)  | 150(66)                        | 200(93)  |
| Back Pressure         | psig(MPa) | 50(0.3)                   | 100(0.7) | 50(0.3)           | 100(0.7) | 50(0.3)        | 100(0.7) | 50(0.3)                     | 100(0.7) | 50(0.3)                        | 100(0.7) |
| Screw Speed           | rpm       | 20                        | 100      | 20                | 100      | 20             | 100      | 20                          | 100      | 20                             | 100      |
| Shot to Cylinder Size | %         | 30                        | 70       | 30                | 70       | 30             | 70       | 30                          | 70       | 30                             | 70       |
| Vent Depth            | in        | 0.0015                    | 0.0020   | 0.0015            | 0.0020   | 0.0015         | 0.0020   | 0.0015                      | 0.0020   | 0.0015                         | 0.0020   |

Table 8-3. Typical Injection Molding Processing for NORYL Resins.

| Processing Parameters | Units     | PX0844<br>PX9406 |          | PX0888<br>SE1X<br>731<br>SE1GFN1<br>HS2000X |          | PX1265<br>PX1391<br>GFN1<br>GFN2<br>GFN3 |          |
|-----------------------|-----------|------------------|----------|---|----------|--|----------|
|                       |           | (min.)           | (max.)   | (min.)                                      | (max.)   | (min.)                                   | (max.)   |
| Drying Temperature    | °F(°C)    | 220(104)         | 230(110) | 220(104)                                    | 230(110) | 220(104)                                 | 230(110) |
| Drying Time (Normal)  | h         | 3                | 4        | 3   | 4        | 3  | 4        |
| Drying Time (Max.)    | h         | –                | 8        | –   | 8        | –  | 8        |
| Maximum Moisture      | %         | –                | 0.02     | –   | 0.02     | –  | 0.02     |
| Melt Temperature      | °F(°C)    | 530(277)         | 580(304) | 540(282)                                    | 590(310) | 560(293)                                 | 600(316) |
| Nozzle                | °F(°C)    | 530(277)         | 580(304) | 540(282)                                    | 590(310) | 560(293)                                 | 600(316) |
| Front Zone            | °F(°C)    | 510(266)         | 580(304) | 520(271)                                    | 590(310) | 540(282)                                 | 600(316) |
| Middle Zone           | °F(°C)    | 490(254)         | 570(299) | 500(260)                                    | 580(304) | 520(271)                                 | 590(310) |
| Rear Zone             | °F(°C)    | 470(243)         | 560(293) | 480(249)                                    | 570(299) | 500(260)                                 | 580(304) |
| Mold Temperature      | °F(°C)    | 160(71)          | 210(99)  | 170(77)                                     | 220(104) | 170(77)                                  | 220(104) |
| Back Pressure         | psig(MPa) | 50(0.3)          | 100(0.7) | 50(0.3)                                     | 100(0.7) | 50(0.3)                                  | 100(0.7) |
| Screw Speed           | rpm       | 20               | 100      | 20  | 100      | 20                                       | 100      |
| Shot to Cylinder Size | %         | 30               | 70       | 30  | 70       | 30                                       | 70       |
| Vent Depth            | in        | 0.0015           | 0.0020   | 0.0015                                      | 0.0020   | –  | –        |

## Machine Selection



NORYL resins can be molded in most standard injection molding machines. Reciprocating screw machines are suggested.

When determining the size of equipment to be used for molding a particular NORYL resin part, total shot weight and total projected area are the two basic factors to be considered.

Optimum results are generally obtained when the total shot weight (all cavities plus runners and sprues) is equal to 30 to 80% of the machine capacity. Very small shots in a large barrel machine may create unnecessarily long resin residence times which may lead to resin degradation.

If it is necessary to mold at the high end of the temperature range, residence time should be minimized to help prevent degradation. Therefore, for higher temperature molding requirements, it is suggested that the minimum shot size should be greater than 60% of the machine's capacity.

Once the total projected area of the complete shot (all cavity and runner areas subjected to injection pressure) has been determined, 3 to 5 tons of clamp force should be provided for each square inch of projected molding area to reduce flashing of the part. Glass-reinforced resins may require slightly higher clamp force (estimate one ton per square inch more). Wall thickness, flow length and molding conditions will determine the actual tonnage required (Figure 8-2.)

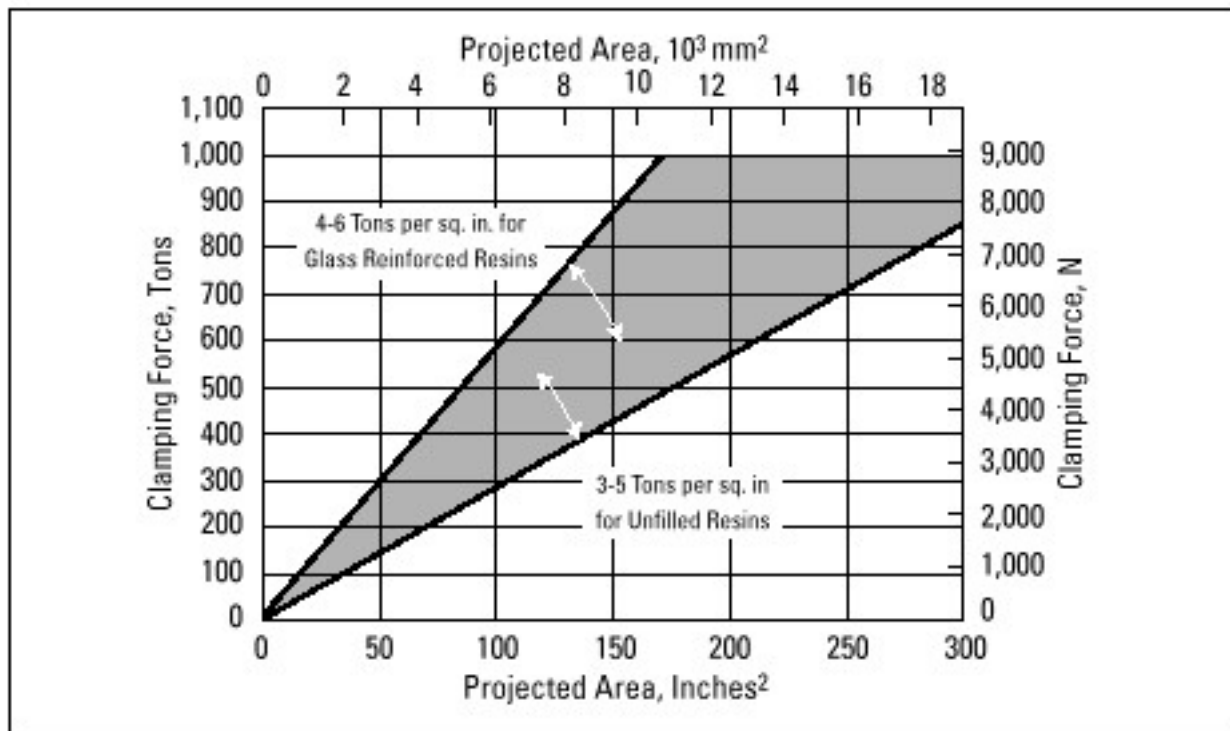

Table 8-2. Clamping Force for NORYL Resins.

## Barrel Selection and Screw Design Considerations



Conventional materials of construction for compatible screws and barrels are generally acceptable for processing NORYL resins. The use of bimetallic barrels is suggested for better abrasion and corrosion resistance.

Depending on screw diameter, a compression ratio of about 2:1 to 2.5:1 with a length to diameter ratio of 20:1 is preferred. A short feed zone (5 flights) and a long compression zone (11 flights) with a gradual constant taper leading to a short metering zone (4 flights) are also suggested. The compression should be accomplished over a gradual and constant taper since sharp transitions can result in excessive shear and material degradation. When

specific screw selection is not possible, general purpose screws with length to diameter ratios from 16:1 through 24:1 and compression ratios from 1.5:1 to 3.0:1 have been used successfully. Vented barrels are not suggested for processing NORYL resins.

## Drying Parameters

---



Although NORYL resin has the lowest moisture absorption of any engineering plastic and may be molded as received in many applications, it is a good practice, particularly where surface appearance is critical, to dry NORYL resin before molding.

Drying is a function of heat transfer and pellet permeability. The main variables affecting these properties are pellet size, temperature, time in the dryer, airflow, and dryer design.

When using air circulating ovens, NORYL pellets should be dried in shallow trays [1 inch to 1-1/2 inches deep (25.4 mm to 38.1 mm)] at suggested times/temperatures.

NORYL resins should not be dried longer than 8 hours. Excessive drying may result in loss of physical properties, color shift, loss of processability or a combination of the three.

The hopper and any open areas of the feed mechanism should be covered to protect the dried pellets from room atmosphere. If a hopper dryer is not available, only a sufficient quantity of dried, heated NORYL pellets should be removed from the oven and placed in the hopper at one time. The length of exposure to ambient atmosphere which the dried resin can withstand before moisture is absorbed can range from 15 minutes to several hours depending on relative humidity.

Where hopper dryers are available, oven drying can also be helpful to dry a quantity of resin for start-up. Air entering the hopper should have a flow of 1.0 CFM for every lb./hr. use.

## Melt Temperature

---



Suggested melt temperatures for NORYL resin are listed in Table 8-3 . Like the majority of thermoplastic molding materials, NORYL resin is sensitive to prolonged exposure to heat. Long residence times and excessive melt temperatures should be avoided to minimize material degradation. A relatively small increase in screw speed (RPM) can result in a dramatic increase in melt temperature with no change in controller set point. It is suggested that melt temperatures be measured using hand-held pyrometers. These measures should be taken on the thermoplastic melts after the machine is on cycle.

When processing near, or at, the upper limit of the melt range, the shot weight should approach 70 to 80% of the cylinder capacity of the machine. If the cylinder temperature exceeds the upper limit of the suggested melt range, thermal degradation of the resin and loss of physical properties may result.

NORYL resin, like other engineered thermoplastics should not be left at elevated temperatures for prolonged periods of time without occasional purging.





## Molding Conditions

|                              |              | <b>N190X<br/>PC180X<br/>SE100X</b> |               | <b>EM7100<br/>HS1000X</b> |               | <b>PXW20<br/>N225X</b> |               | <b>EM6100<br/>EM6100F<br/>EM6101</b> |               | <b>EM7301F<br/>EM7304F<br/>HMC3008A</b> |               |
|------------------------------|--------------|------------------------------------|---------------|---------------------------|---------------|------------------------|---------------|--------------------------------------|---------------|---|---------------|
| <b>Processing Parameters</b> | <b>Units</b> | <b>(min.)</b>                      | <b>(max.)</b> | <b>(min.)</b>             | <b>(max.)</b> | <b>(min.)</b>          | <b>(max.)</b> | <b>(min.)</b>                        | <b>(max.)</b> | <b>(min.)</b>                           | <b>(max.)</b> |
| Drying Temperature           | °F(°C)       | 170(77)                            | 180(82)       | 190(88)                   | 200(93)       | 200(93)                | 210(99)       | 200(93)                              | 220(104)      | 210(99)                                 | 220(104)      |
| Drying Time (Normal)         | h            | 3                                  | 4             | 3                         | 4             | 3                      | 4             | 3                                    | 4             | 3                                       | 4             |
| Drying Time (Max.)           | h            | –                                  | 8             | –                         | 8             | –                      | 8             | –                                    | 8             | –                                       | 8             |
| Maximum Moisture             | %            | –                                  | 0.02          | –                         | 0.02          | –                      | 0.02          | –                                    | 0.02          | –                                       | 0.02          |
| Melt Temperature             | °F(°C)       | 480(249)                           | 530(277)      | 490(254)                  | 540(282)      | 500(260)               | 550(288)      | 510(266)                             | 560(293)      | 520(271)                                | 570(299)      |
| Nozzle                       | °F(°C)       | 480(249)                           | 530(277)      | 490(254)                  | 540(282)      | 500(260)               | 550(288)      | 510(266)                             | 560(293)      | 520(271)                                | 570(299)      |
| Front Zone                   | °F(°C)       | 460(238)                           | 530(277)      | 470(243)                  | 540(282)      | 480(249)               | 550(288)      | 490(254)                             | 560(293)      | 500(260)                                | 570(299)      |
| Middle Zone                  | °F(°C)       | 440(227)                           | 520(271)      | 450(232)                  | 530(277)      | 460(238)               | 540(282)      | 470(243)                             | 550(288)      | 480(249)                                | 560(293)      |
| Rear Zone                    | °F(°C)       | 420(216)                           | 510(266)      | 430(221)                  | 520(271)      | 440(227)               | 530(277)      | 450(232)                             | 540(282)      | 460(238)                                | 550(288)      |
| Mold Temperature             | °F(°C)       | 130(54)                            | 170(77)       | 150(66)                   | 190(88)       | 160(71)                | 200(93)       | 150(66)                              | 200(93)       | 150(66)                                 | 200(93)       |
| Back Pressure                | psig(MPa)    | 50(0.3)                            | 100(0.7)      | 50(0.3)                   | 100(0.7)      | 50(0.3)                | 100(0.7)      | 50(0.3)                              | 100(0.7)      | 50(0.3)                                 | 100(0.7)      |
| Screw Speed                  | rpm          | 20                                 | 100           | 20                        | 100           | 20                     | 100           | 20                                   | 100           | 20                                      | 100           |
| Shot to Cylinder Size        | %            | 30                                 | 70            | 30                        | 70            | 30                     | 70            | 30                                   | 70            | 30                                      | 70            |
| Vent Depth                   | in           | 0.0015                             | 0.0020        | 0.0015                    | 0.0020        | 0.0015                 | 0.0020        | 0.0015                               | 0.0020        | 0.0015                                  | 0.0020        |

Table 8-3. Typical Injection Molding Processing for NORYL Resins.

|                              |              | <b>PX0844<br/>PX9406</b> |               | <b>PX0888<br/>SE1X<br/>731<br/>SE1GFN1<br/>HS2000X</b> |               | <b>PX1265<br/>PX1391<br/>GFN1<br/>GFN2<br/>GFN3</b> |               |
|------------------------------|--------------|--------------------------|---------------|--|---------------|---|---------------|
| <b>Processing Parameters</b> | <b>Units</b> | <b>(min.)</b>            | <b>(max.)</b> | <b>(min.)</b>  | <b>(max.)</b> | <b>(min.)</b>                                       | <b>(max.)</b> |
| Drying Temperature           | °F(°C)       | 220(104)                 | 230(110)      | 220(104)   | 230(110)      | 220(104)  | 230(110)      |
| Drying Time (Normal)         | h            | 3                        | 4             | 3  | 4             | 3   | 4             |
| Drying Time (Max.)           | h            | –                        | 8             | –  | 8             | –   | 8             |
| Maximum Moisture             | %            | –                        | 0.02          | –  | 0.02          | –   | 0.02          |
| Melt Temperature             | °F(°C)       | 530(277)                 | 580(304)      | 540(282)   | 590(310)      | 560(293)  | 600(316)      |
| Nozzle                       | °F(°C)       | 530(277)                 | 580(304)      | 540(282)   | 590(310)      | 560(293)  | 600(316)      |
| Front Zone                   | °F(°C)       | 510(266)                 | 580(304)      | 520(271)   | 590(310)      | 540(282)  | 600(316)      |
| Middle Zone                  | °F(°C)       | 490(254)                 | 570(299)      | 500(260)   | 580(304)      | 520(271)  | 590(310)      |
| Rear Zone                    | °F(°C)       | 470(243)                 | 560(293)      | 480(249)   | 570(299)      | 500(260)  | 580(304)      |
| Mold Temperature             | °F(°C)       | 160(71)                  | 210(99)       | 170(77)  | 220(104)      | 170(77)   | 220(104)      |
| Back Pressure                | psig(MPa)    | 50(0.3)                  | 100(0.7)      | 50(0.3)  | 100(0.7)      | 50(0.3)   | 100(0.7)      |
| Screw Speed                  | rpm          | 20                       | 100           | 20   | 100           | 20  | 100           |
| Shot to Cylinder Size        | %            | 30                       | 70            | 30   | 70            | 30  | 70            |
| Vent Depth                   | in           | 0.0015                   | 0.0020        | 0.0015   | 0.0020        | –   | –             |

## Mold temperature



The usual range for processing unreinforced NORYL grades is from 150 to 200°F (66 to 93°C). Operating molds in this temperature range can also be used to improve flow, knitline strength and surface finish.

Typical molding temperatures for NORYL resins are presented in Table 8-3 .

## Screw Speed



Screw speeds (RPM) should be adjusted to permit screw rotation during the entire cooling cycle without delaying the overall cycle (Figure 8-3). Low screw speeds can help reduce glass fiber damage during plastication when molding reinforced grades.

Suggested screw speed is dependent on screw diameter. Optimum linear velocity of screw O.D is 8 inches (202.4 mm) per second.  $RPM = \text{screw diameter } 3.1416 \text{ divided into the optimum linear velocity of 8 inches (202.4 mm) per second} \times 3.1416 = 9.4248 \text{ divided into 8 inches (202.4 mm) per second (optimum linear velocity)} \times 60 = 51 \text{ RPM.}$

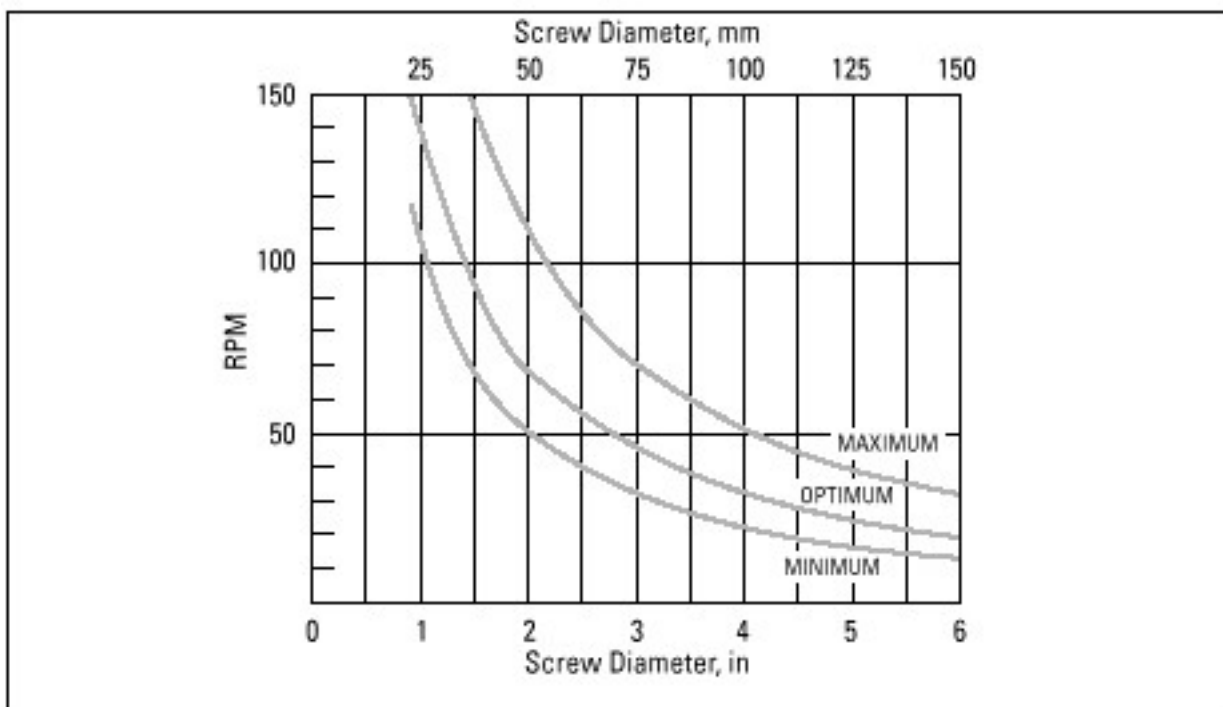

Figure 8-3. Screw Speed Suggestions for NORYL Resins.

## Back Pressure



A back pressure of 50 to 100 psi (0.3 to 0.7 MPa) is suggested to promote a homogeneous melt and help maintain consistent shot size. Higher back pressures used to improve melt mixing result in higher melt temperatures.

When molding reinforced grades, low back pressure will help reduce glass fiber damage during plastication.



## Shot Size

---



The shot size should dictate the size of machine used. It is suggested that the optimum shot be 40 to 60% of the machine's barrel capacity. However, shots which are 20 to 75% of machine capacity have been successfully molded when temperatures were precisely maintained and all processing conditions were very closely controlled.

## Ram Speed

---



When selecting injection speed, careful consideration must be given to adequate mold venting, resin melt temperature and injection pressure, along with the potential for jetting.

The fastest fill speed possible generally provides longer flow, fills thinner wall sections, and creates better surface finish. In thick parts, slow fill helps reduce voids. Thin-wall sections below 0.06 inch (1.52 mm) virtually always require fast ram speeds in order to fill the cavity and helps produce high knitline strength. The fill rate of thick sections may be reduced to aid packing when filling through restricted gates.

Programmed injection is suggested for parts with small gates (pin gates and subgates). A slow injection rate can be used at the start to help reduce shear, jetting, and burning of the material.

## Injection Pressure

---



The actual injection pressure will depend on variables such as melt temperature, mold temperature, part geometry, wall thickness, flow length and other mold and equipment considerations. Generally, the lowest pressures which provide the desired properties, appearance, and molding cycle are preferred.

Holding pressures from 60 to 80% of the injection pressure are usually adequate for normal requirements.

## Cushion

---



The use of a small cushion (1/8 inch (3.18 mm) suggested) reduces material residence time in the barrel and helps accommodate machine variations.

## Cycle Time



When adjusting cycle times, it is typically best to use a fast injection speed and a minimum holding time to achieve gate freeze-off and a short cooling time.

The fastest possible ram travel time is preferred for most parts. The thickest wall section of the part normally sets the cycle time. Figure 8-4 illustrates the overall cycle time prediction as a function of wall thickness. A runner/sprue section could exceed the part wall thickness and extend cycle times shown in Figure 8-4. This should be a consideration before the tool is built, as well as during actual molding.

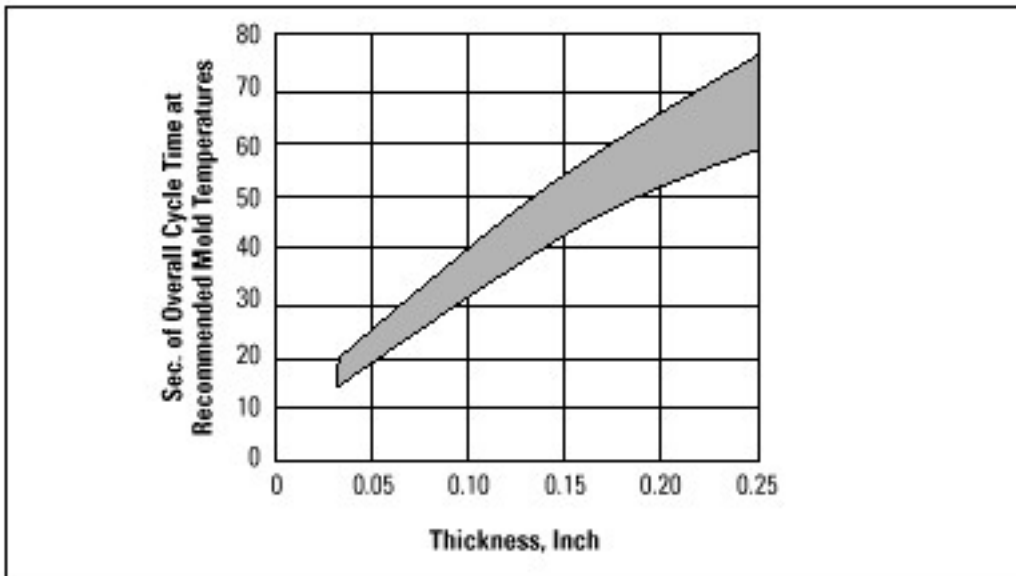

Figure 8-4. Typical Cycle Time vs. Wall Thickness for NORLYL Resins.

## Effect of Wall Thickness on Flow Length



Variables affecting melt flow length include wall thickness, mold temperature injection pressure, melt temperature and material composition.

Diskflow (or radial flow) results can be obtained from mold filling computer simulation. An example of diskflow is provided in Figure 8-5.

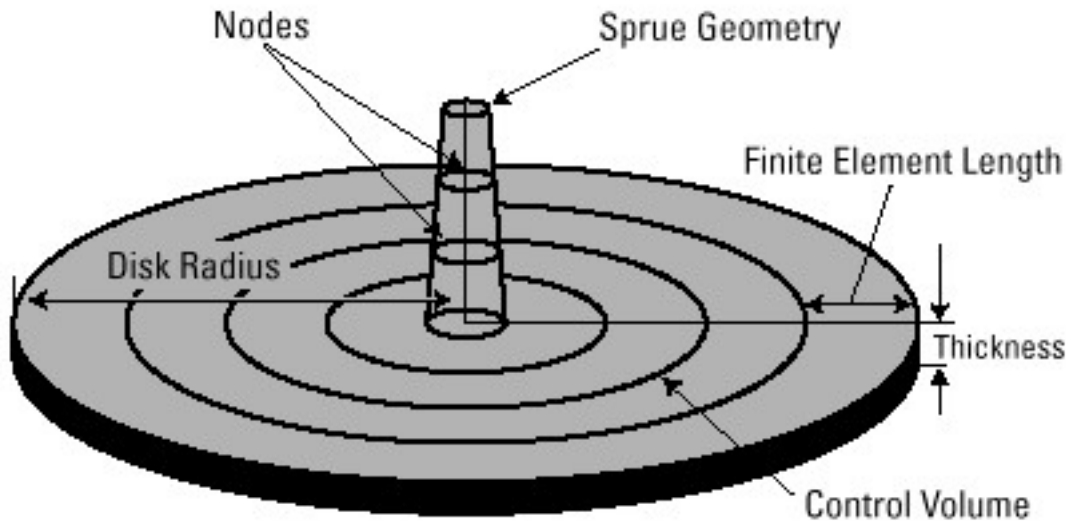

Figure 8-5. Diskflow Model.

Shown is the relationship of flow length versus wall thickness at a given cavity pressure (pressure at sprue ) and melt temperature (Figures 8-6 through 8-9). Diskflow radial flow results are normally conservative and may underpredict the flow lengths of many applications where flow is not entirely radial.

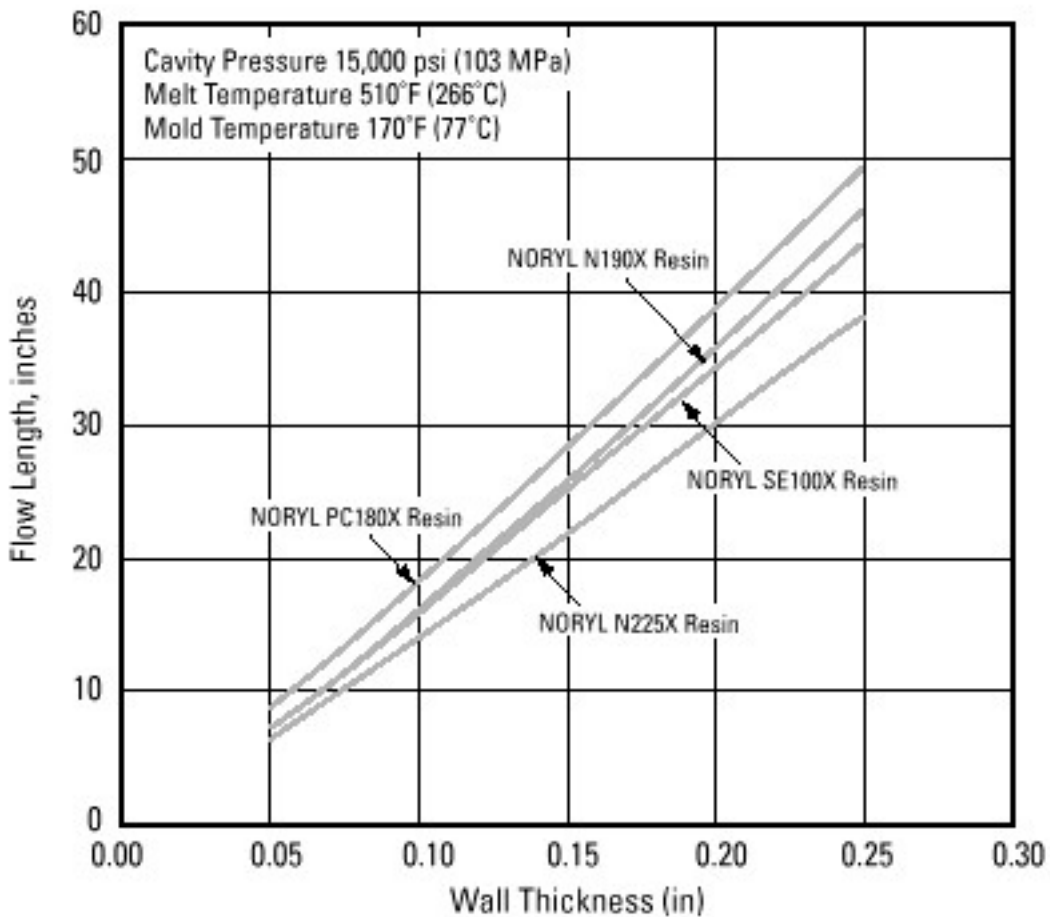

Figure 8-6. Diskflow—Flow Length vs. Wall Thickness NORYL Resin Standard Unreinforced Grades\*.

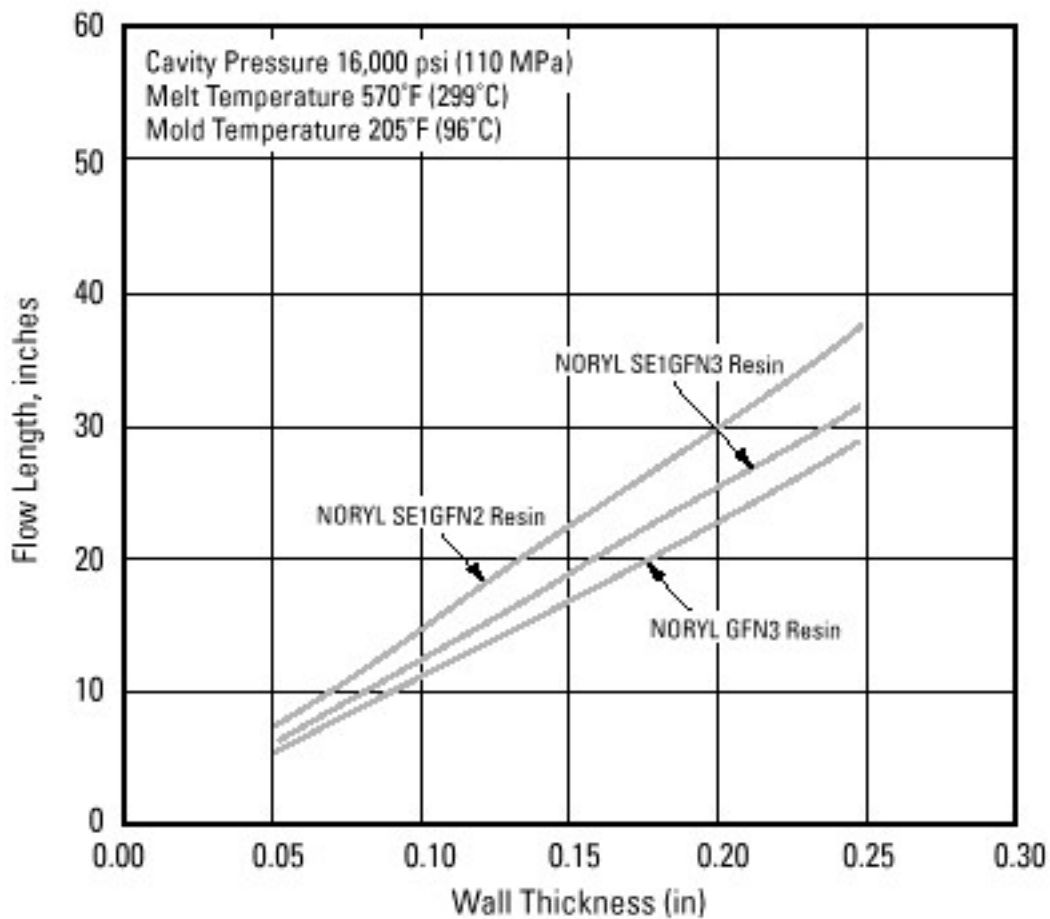

Figure 8-7. Diskflow-Flow Length vs. Wall Thickness NORYL Resin Standard (Higher HDT) Unreinforced\* Grades.

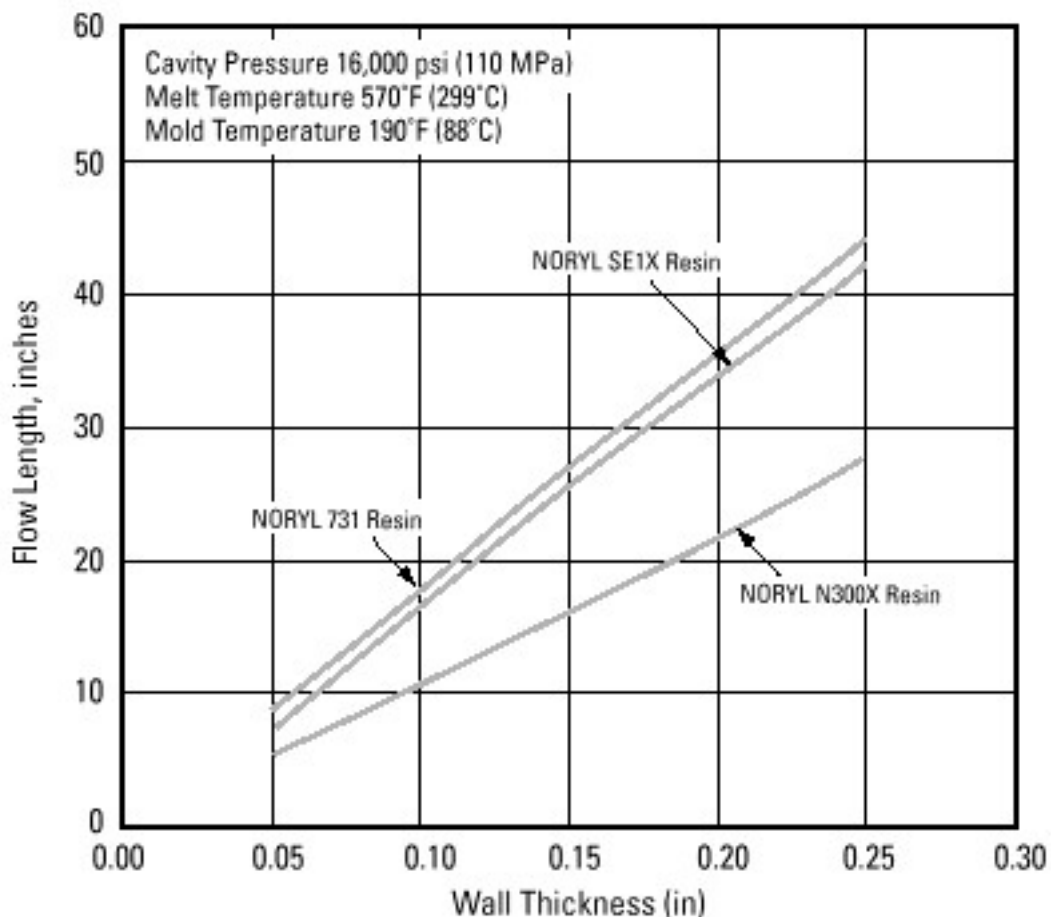

Figure 8-8. Diskflow-Flow Length vs. Wall Thickness NORYL Resin Glass-Reinforced Grades\*.

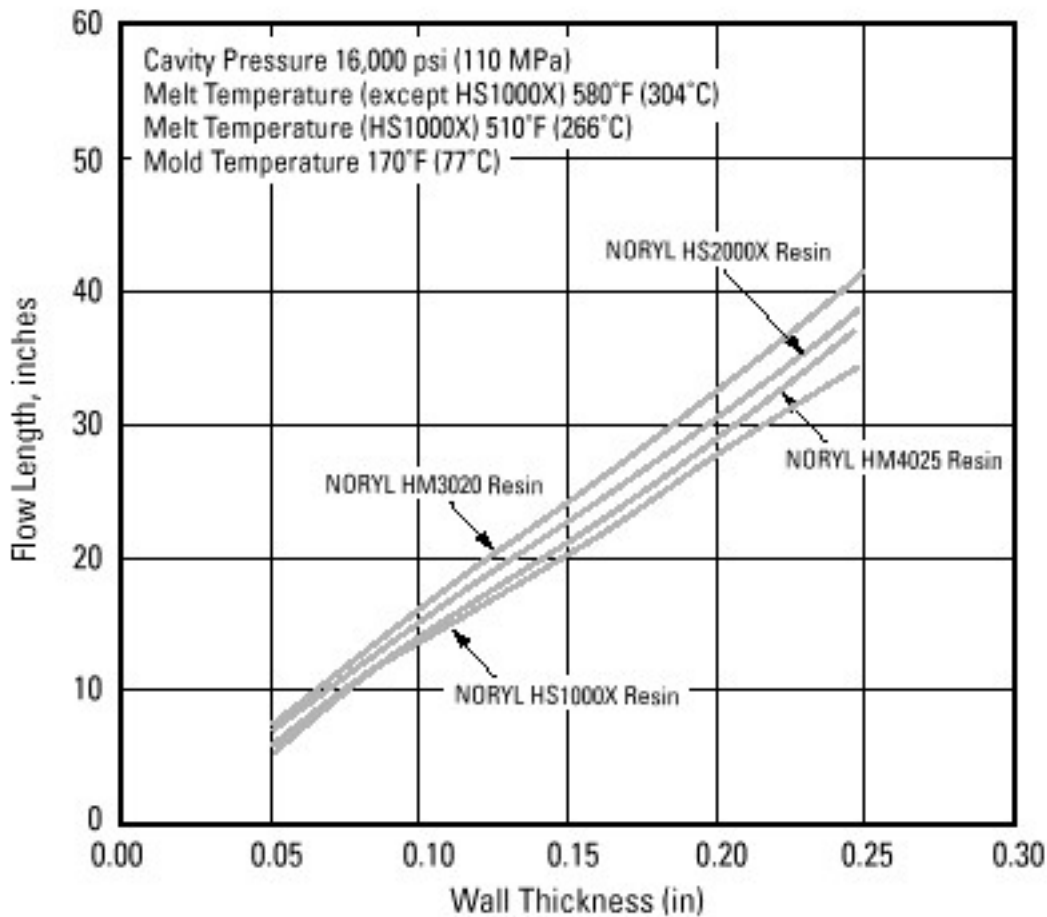

Figure 8-9. Diskflow–Flow Length vs. Wall Thickness NORYL Resin Mineral Filled Grades\*.

\*Results obtained from mold filling computer simulation. Flow length is calculated at point in time when maximum pressure is reached and flow length begins to drop.

## Mold Release



Smooth surface finish, lubricity and good tool design help to make parts molded in NORYL resin generally easy to eject from the mold without the use of mold release agents.

The ability to reproduce intricate detail can sometimes interfere with mold release if the mold surface has imperfections such as tool marks, nicks, scratches, poor polish or EDM finish. These conditions could form undercuts that hinder part removal.

If part intricacy causes part removal difficulties, a light dusting of zinc stearate may be used to facilitate removal. Other mold releases should be tested for chemical compatibility with NORYL resins, although most silicones and fluorocarbons have been found to be suitable.

Some mold release agents can cause severe adhesion problems for secondary finishing systems such as painting or hot stamping. When secondary finishing is intended, the avoidance of release agents or the use of zinc stearate is suggested. Internal lubricants are generally not suggested for use with NORYL resins because they can have a deleterious effect on part properties.

## Downtime

---



**When it becomes necessary to stop molding, the following steps are suggested:**

- Maintain cylinder temperature for interruptions up to 15 minutes.
- Decrease cylinder temperature by 100°F (56°C) for periods from 15 minutes to 2 hours.
- Reduce further to 350°F (177°C) for interruptions from 2 to 12 hours.
- Purge out barrel and shut off heat for periods longer than 12 hours.

## Purging

---



Polystyrene and reground cast acrylic are effective purging materials for all NORYL resins. Purging should be done within the melt temperature range for that particular grade of resin. It is important to have proper ventilation during the purging procedures.

## Regrind

---



If the application permits the use of regrind, reground sprues, runners, and non-degraded parts may be added to the virgin pellets up to a level of 25%. Grinder screen sizes should be 5/16 to 3/8 inch (7.9 to 9.5 mm). If a smaller size is used, too many fines could be generated, creating molding problems such as streaking and burning. It is important to keep the ground parts clean and to avoid contamination from other materials. Drying time should be increased since regrind will not be the same size as virgin pellets, and therefore water diffusion will be different. Regrind utilization may produce some effect on color. Actual regrind usage should be determined for each individual application (See Figures 8-10 through 8-12).



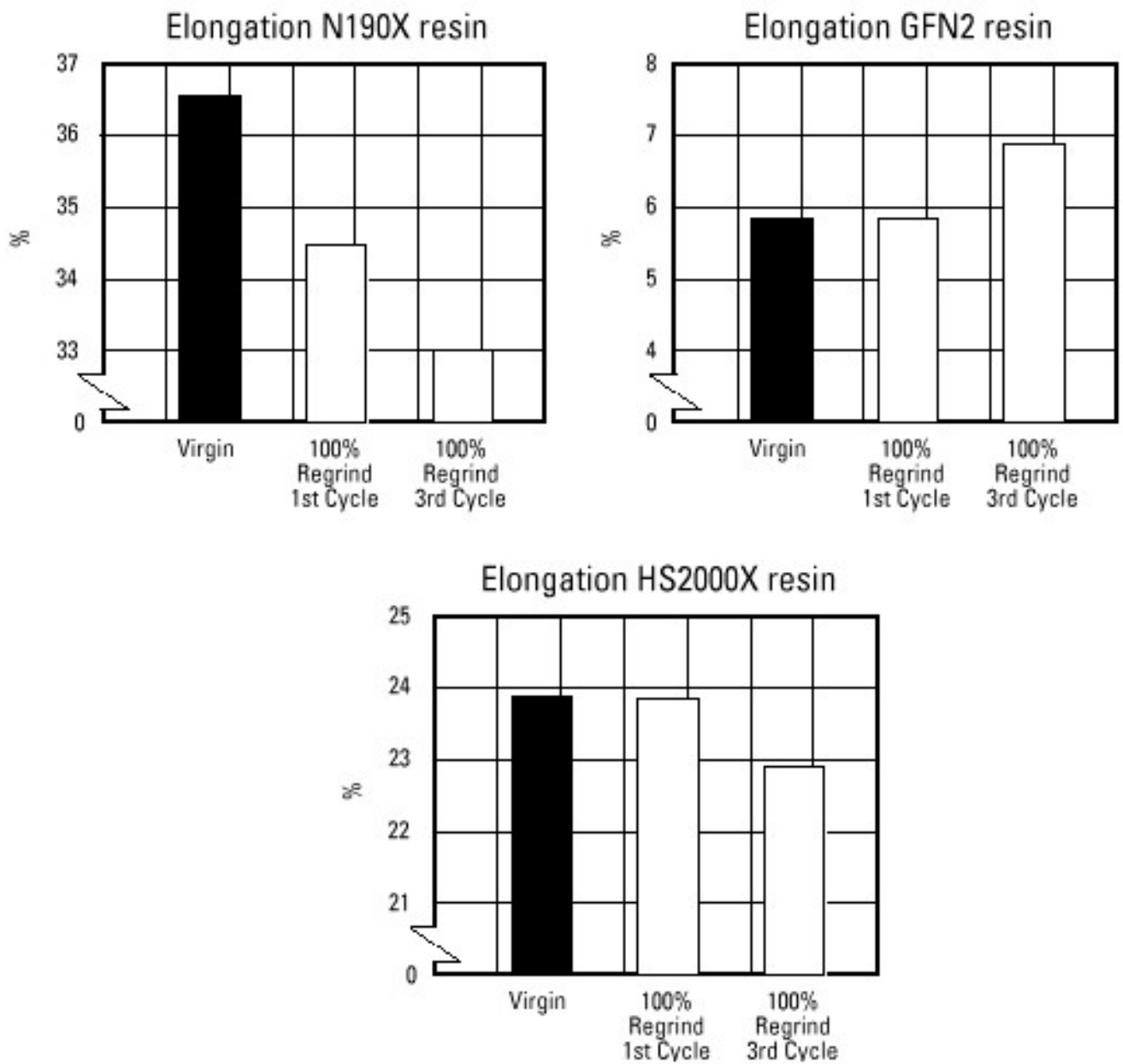

Figure 8-10. Effect of Regrind on NORYL Resin Properties – NORYL Elongation (Selected Grades).

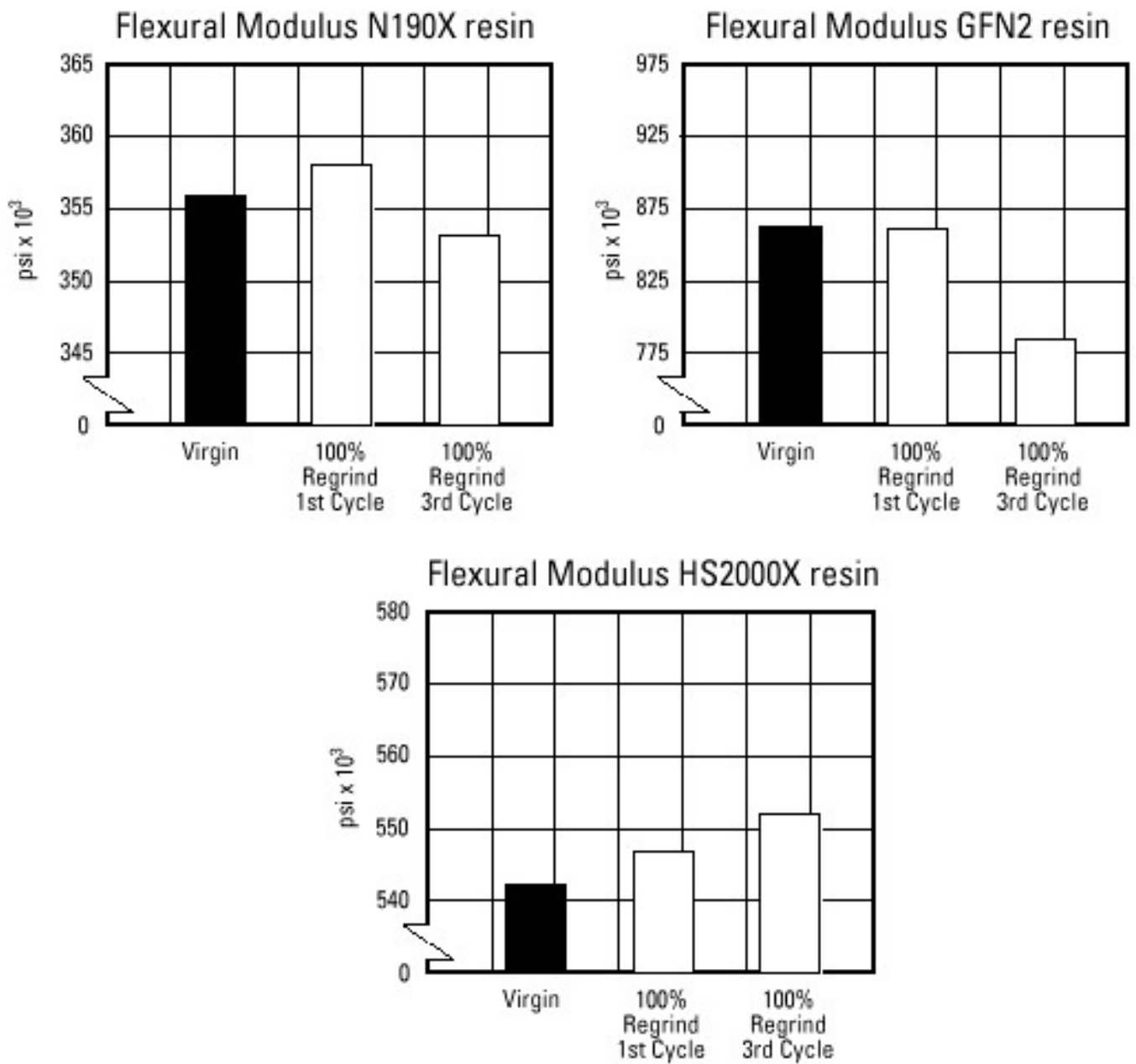

Figure 8-11. Effect of Regrind on NORYL Resin Properties – NORYL Flexural Modulus (Selected Grades).

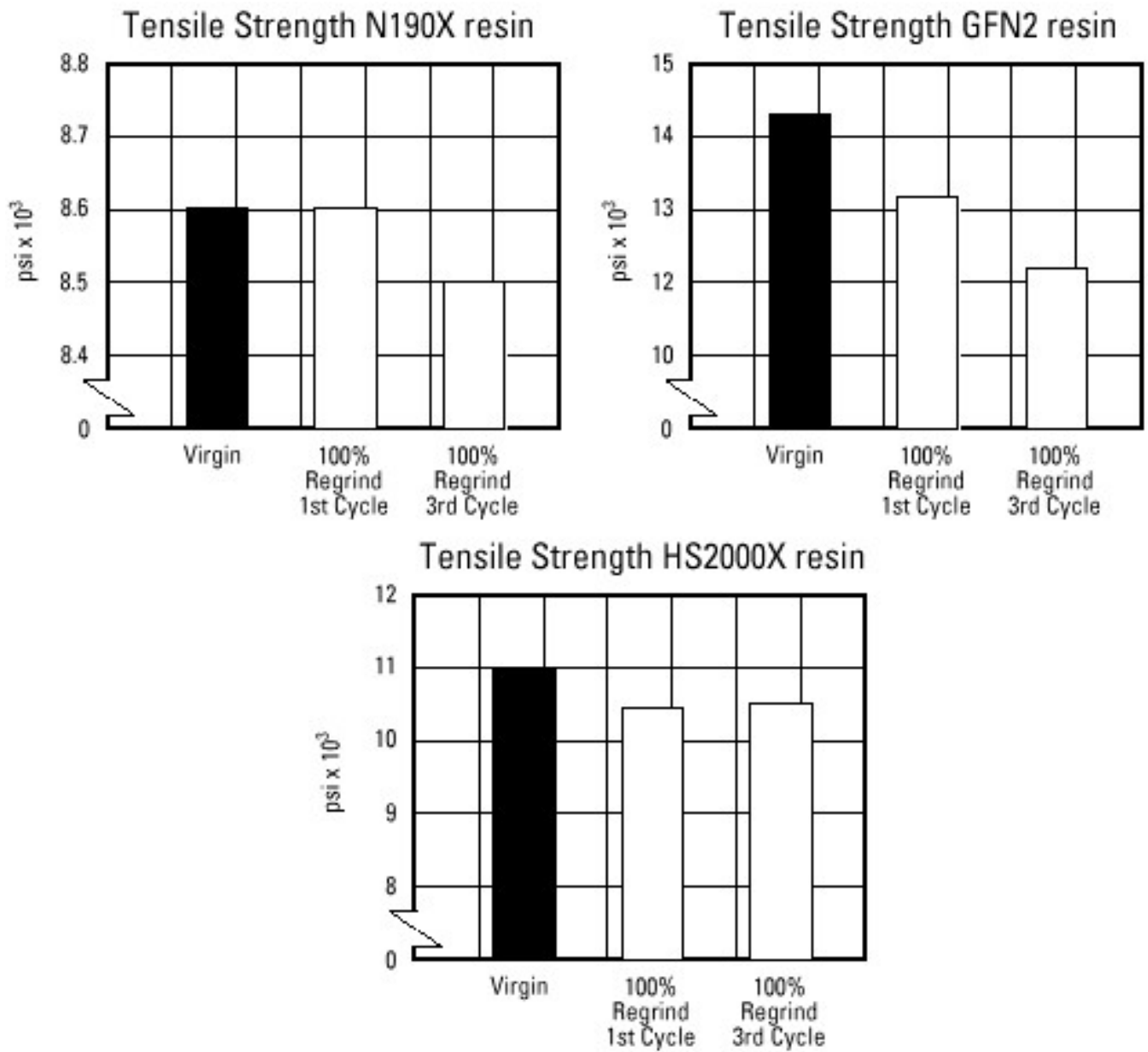

Figure 8-12. Effect of Regrind on NORYL Resin Properties – NORYL Tensile Strength (Selected Grades).

DISCLAIMER: THE MATERIALS AND PRODUCTS OF THE BUSINESSES MAKING UP THE GE PLASTICS UNIT OF GENERAL ELECTRIC COMPANY\*, USA, ITS SUBSIDIARIES AND AFFILIATES ("GEP"), ARE SOLD SUBJECT TO GEP'S STANDARD CONDITIONS OF SALE, WHICH ARE INCLUDED IN THE APPLICABLE DISTRIBUTOR OR OTHER SALES AGREEMENT, PRINTED ON THE BACK OF ORDER ACKNOWLEDGMENTS AND INVOICES, AND AVAILABLE UPON REQUEST. ALTHOUGH ANY INFORMATION, RECOMMENDATIONS, OR ADVICE CONTAINED HEREIN IS GIVEN IN GOOD FAITH, GEP MAKES NO WARRANTY OR GUARANTEE, EXPRESS OR IMPLIED, (I) THAT THE RESULTS DESCRIBED HEREIN WILL BE OBTAINED UNDER END-USE CONDITIONS, OR (II) AS TO THE EFFECTIVENESS OR SAFETY OF ANY DESIGN INCORPORATING GEP MATERIALS, PRODUCTS, RECOMMENDATIONS OR ADVICE. EXCEPT AS PROVIDED IN GEP'S STANDARD CONDITIONS OF SALE, GEP AND ITS REPRESENTATIVES SHALL IN NO EVENT BE RESPONSIBLE FOR ANY LOSS RESULTING FROM ANY USE OF ITS MATERIALS OR PRODUCTS DESCRIBED HEREIN. Each user bears full responsibility for making its own determination as to the suitability of GEP's materials, products, recommendations, or advice for its own particular use. Each user must identify and perform all tests and analyses necessary to assure that its finished parts incorporating GEP materials or products will be safe and suitable for use under end-use conditions. Nothing in this or any other document, nor any oral recommendation or advice, shall be deemed to alter, vary, supersede, or waive any provision of GEP's Standard Conditions of Sale or this Disclaimer, unless any such modification is specifically agreed to in a writing signed by GEP. No statement contained herein concerning a possible or suggested use of any material, product or design is intended, or should be construed, to grant any license under any patent or other intellectual property right of General Electric Company or any of its subsidiaries or affiliates covering such use or design, or as a recommendation for the use of such material, product or design in the infringement of any patent or other intellectual property right.

\* Company not connected with the English company of a similar name.

Lexan\*, Noryl\*, Noryl EF\*, Noryl GTX\*, Noryl\* Xtra, Valox\*, Ultem\*, Xenoy\*, Cyclocac\*, Cycloy\*, Enduran\*, Gelon\* and Geloy\* are Registered Trademarks of General Electric Co., USA.