

LN140N10AAC

100V N-Channel Power MOSFET

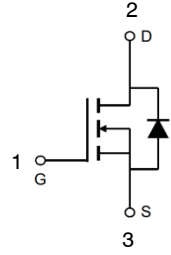
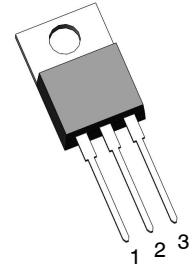

TO220

1. FEATURES

- Low on-resistance and low gate-charge.
- Fast switching speed.
- We declare that the material of product compliance with RoHS requirements and Halogen Free.

2. APPLICATIONS

- Power Tools
- DC/DC Conversion
- Motor Control

3. DEVICE MARKING AND RESISTOR VALUES

Device	Marking	Shipping
LN140N10AAC	N140N10AAC	50/Tube

4. MAXIMUM RATINGS

Parameter	Symbol	Limits	Unit
Drain-to-Source Voltage	VDS	100	V
Gate-to-Source Voltage	VGS	±20	V
Continuous Drain Current(Note 1)	ID	TA =25°C	25
		TA =100°C	15
Pulsed Drain Current(Note 2)	IDM	100	A
Continuous Drain Current	ID	TC =25°C	140
		TC =100°C	85
Pulsed Drain Current	IDM	560	A
Avalanche Current	IAS	40	A
Avalanche energy(L=1mH)	EAS	800	mJ
Power Dissipation(Note 1)	PD	TA =25°C	2.1
		TA =100°C	0.83
Power Dissipation	PD	TC =25°C	83
		TC =100°C	33
Operating Junction and Storage Temperature Range	TJ , TSTG	-55~+150	°C

5. THERMAL CHARACTERISTICS

Parameter	Symbol	Max	Unit
Junction-to-Ambient(Note 1)	RθJA	60	°C/W
Junction-to-Case	RθJC	1.5	

Note:1.Surface mounted on "1.5in x 1.5in" FR4 board using 1*1 in pad, 2 oz Cu.

2.Pulse width limited by maximum junction temperature.

6. ELECTRICAL CHARACTERISTICS

Characteristic	Symbol	Min.	Typ.	Max.	Unit
Static					
Drain to Source Breakdown Voltage (VGS = 0 V, ID = 250 μ A)	BVDSS	100	-	-	V
Gate-Source Threshold Voltage (VDS = VGS, ID = 250 μ A)	VGS(th)	2	-	4	V
Gate-Body Leakage (VDS = 0 V, VGS = \pm 20 V)	IGSS	-	-	\pm 100	nA
Zero Gate Voltage Drain Current (VDS = 100 V, VGS = 0 V)	IDSS	-	-	1	μ A
Drain-Source On-Resistance(Note 3) (VGS = 10 V, ID = 20 A)	RDS(on)	-	2.1	2.5	m Ω
Dynamic					
Input Capacitance	(VDS = 50 V, VGS = 0 V, f = 100kHz)	Ciss	-	9938	pF
Output Capacitance		Coss	-	3267	
Reverse Transfer Capacitance		Crss	-	85	
Total Gate Charge	(VDS = 50 V, VGS = 10 V, ID = 20 A)	Qg	-	140	nC
Gate-Source Charge		Qgs	-	40	
Gate-Drain Charge		Qgd	-	23	
Turn-On Delay Time	(VDS = 50 V, ID = 20 A, VGS = 10 V, RG = 10 Ω)	td(on)	-	76	ns
Rise Time		tr	-	60	
Turn-Off Delay Time		td(off)	-	242	
Fall Time		tf	-	94	
Gate Resistance (VDS = 0 V, VGS = 0 V, f = 1.0MHz)	Rg	-	100	-	Ω
Diode characteristics					
Continuous Current TC =25° C	IS	-	-	140	A
Plused Current TC =25° C	ISM	-	-	560	A
Diode Forward Voltage (IS = 20 A, VGS = 0 V)	VSD	-	-	1.3	V
Reverse Recovery Time (VR=50V,IF=10A,dIF/dt=100A/us)	trr	-	135	-	ns
Reverse Recovery Charge (VR=50V,IF=10A,dIF/dt=100A/us)	Qrr	-	405	-	nC
Reverse Recovery Current (VR=50V,IF=10A,dIF/dt=100A/us)	IRRM	-	6	-	A

3.Pulse test: PW \leq 300us duty cycle \leq 2%.

7. ELECTRICAL CHARACTERISTICS CURVES

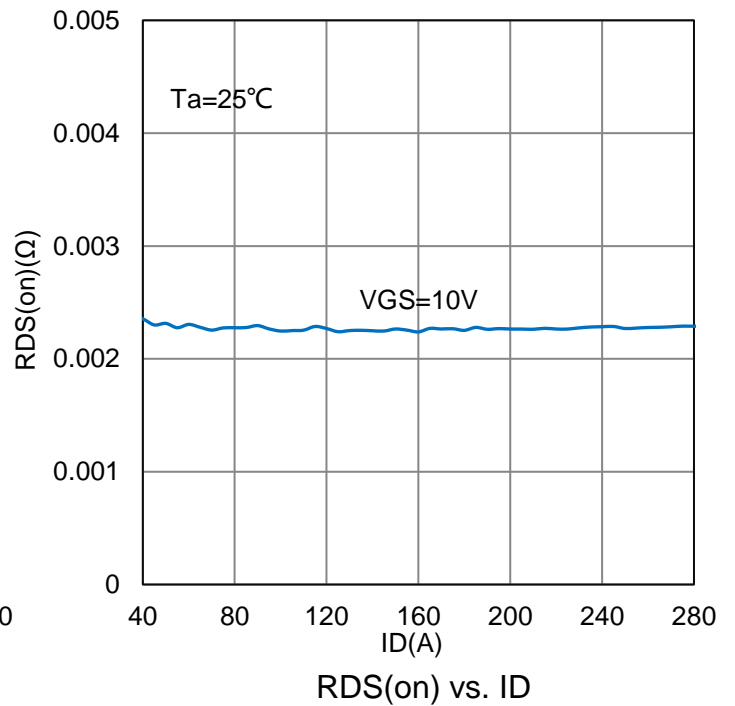
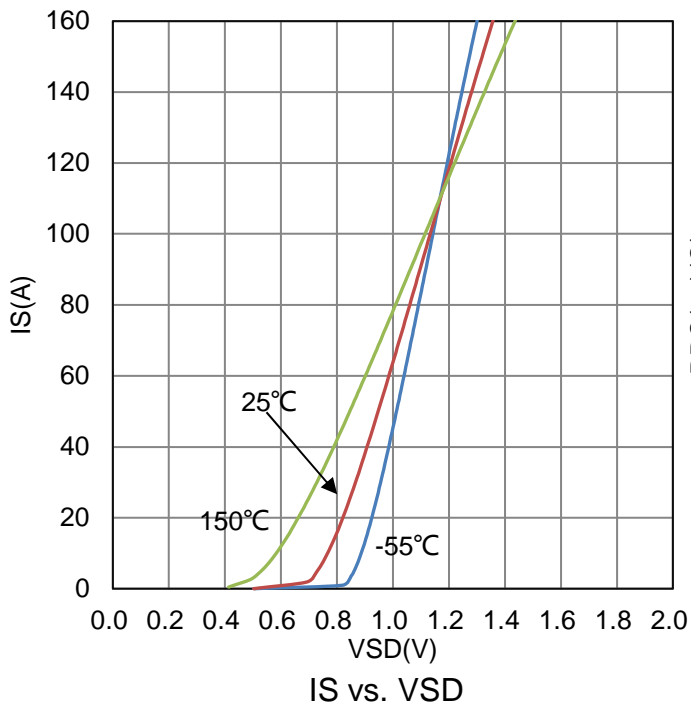
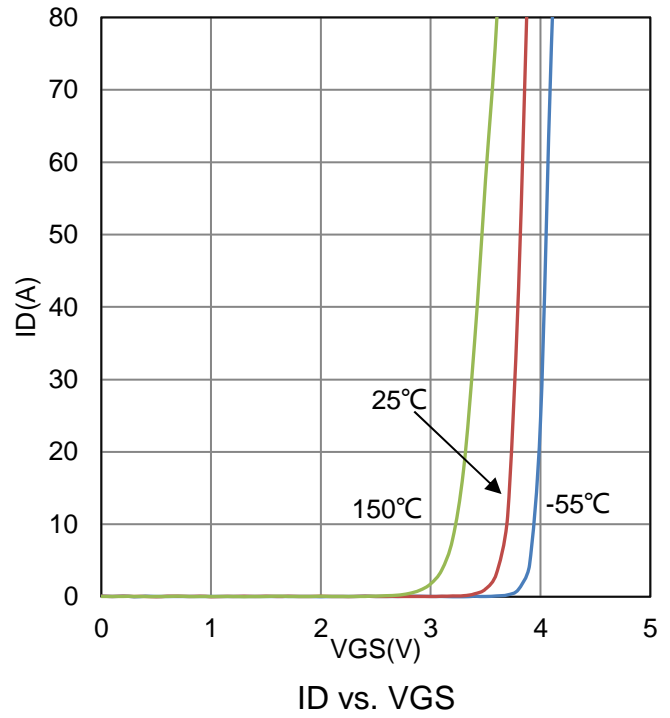
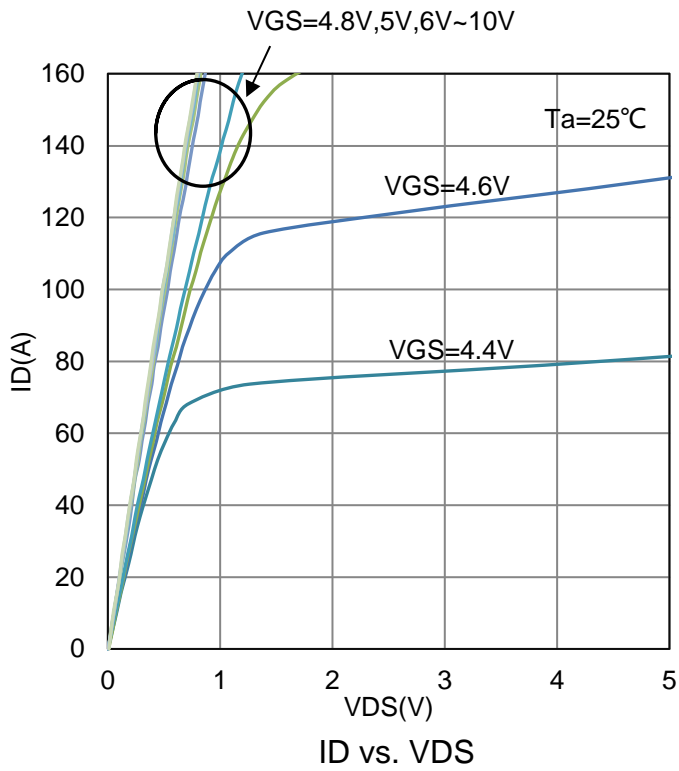

7. ELECTRICAL CHARACTERISTICS CURVES(Con.)

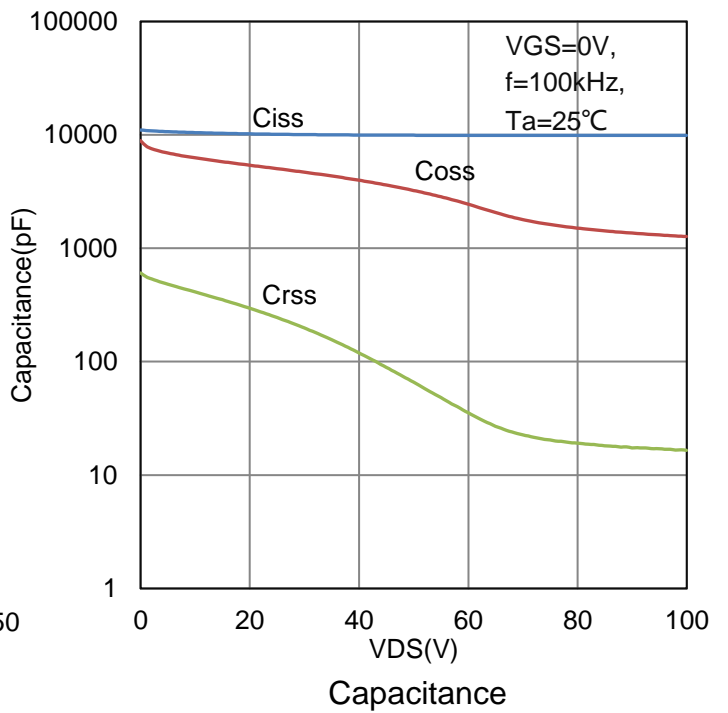
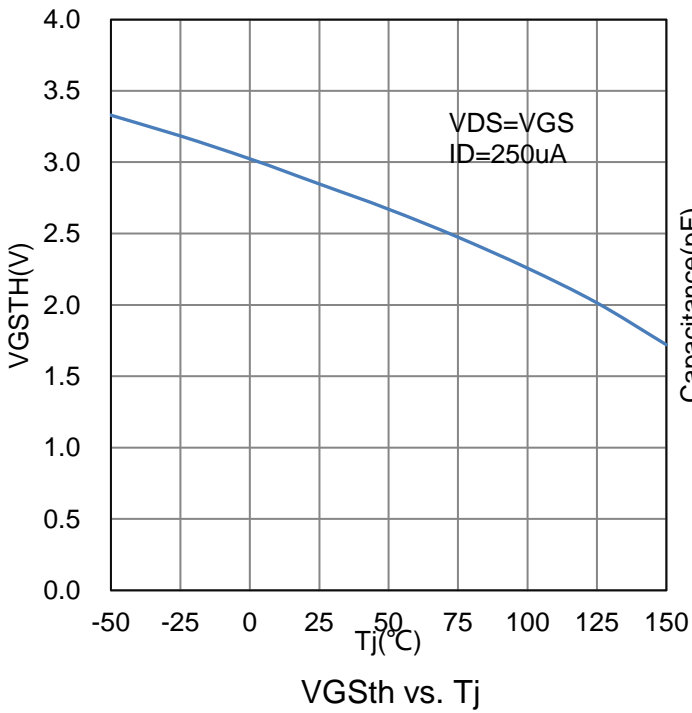
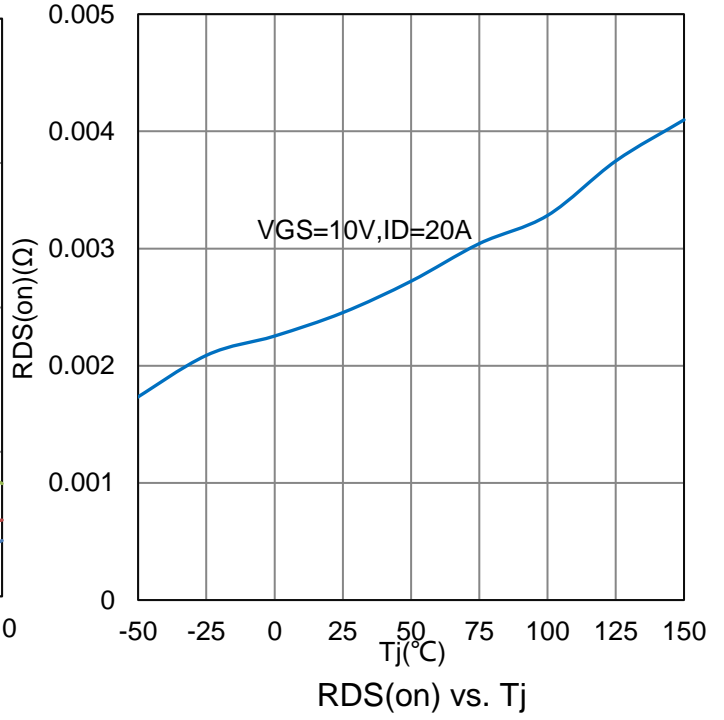
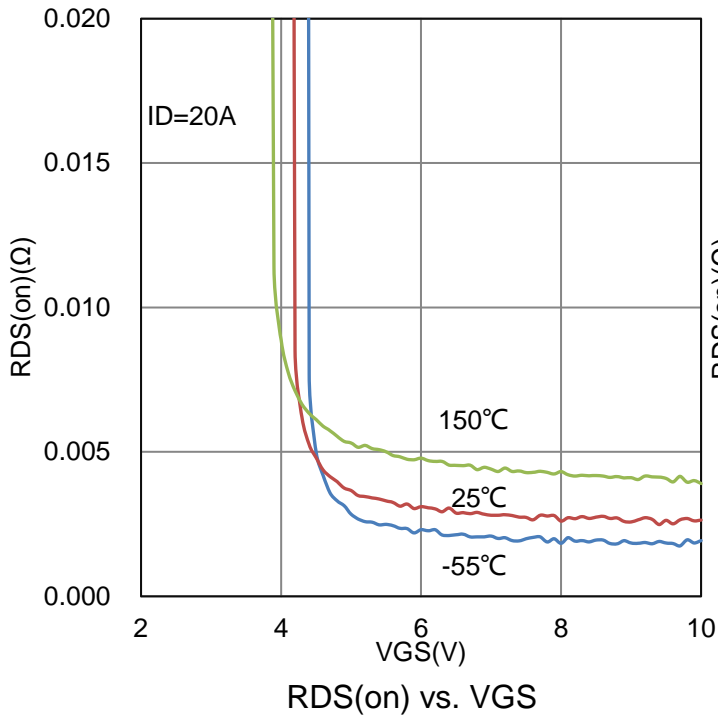

7. ELECTRICAL CHARACTERISTICS CURVES(Con.)

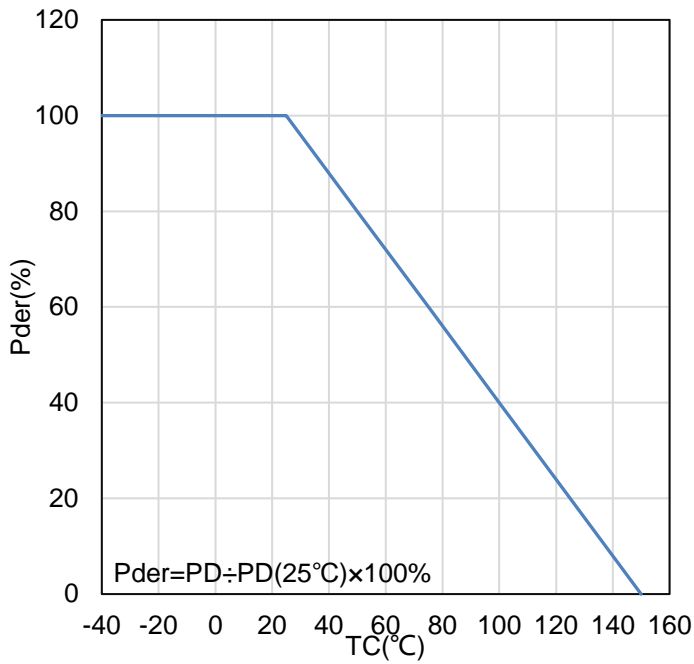

Normalized Derating Curve

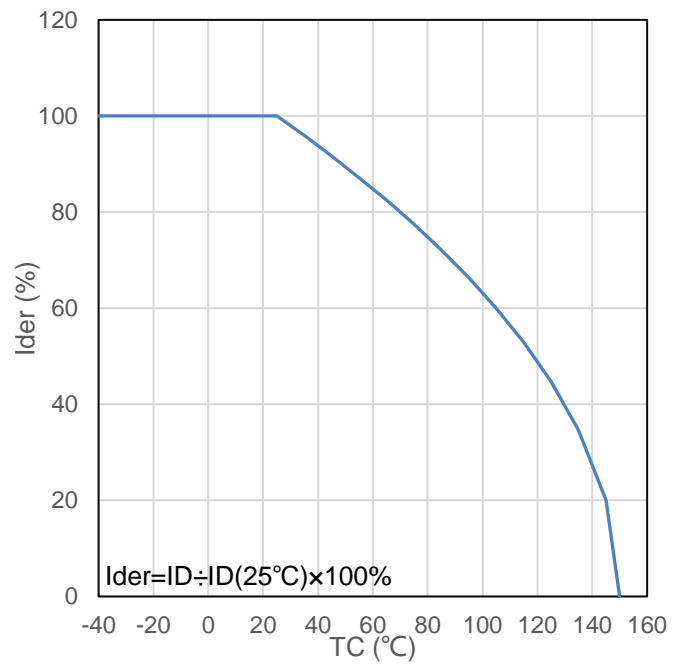

Normalized drain Current

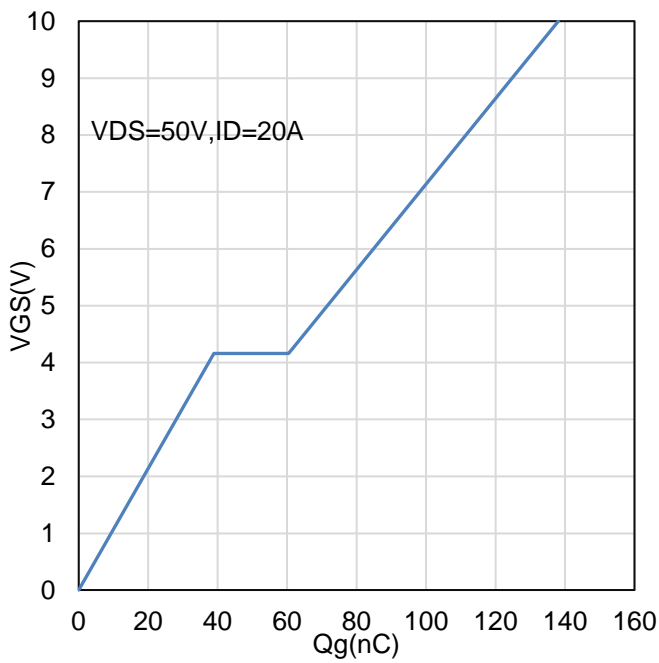

VGS vs. Qg

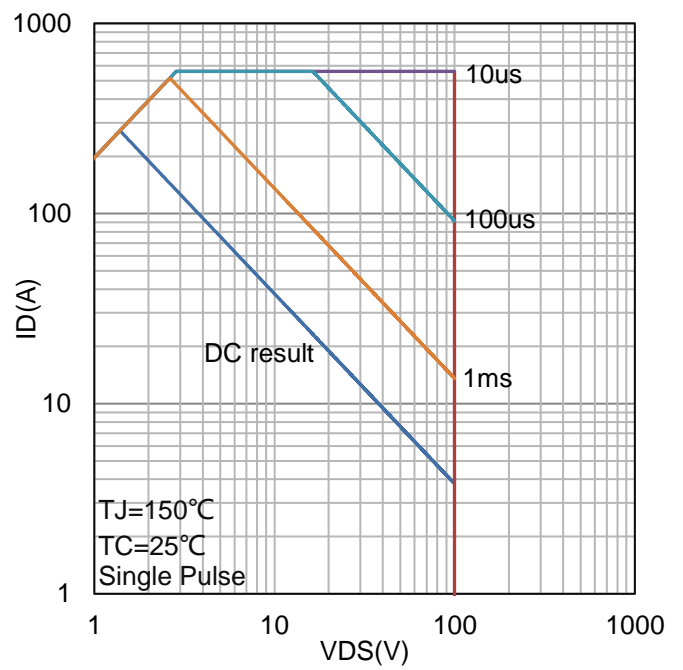

Safe Operating Area

7. ELECTRICAL CHARACTERISTICS CURVES(Con.)

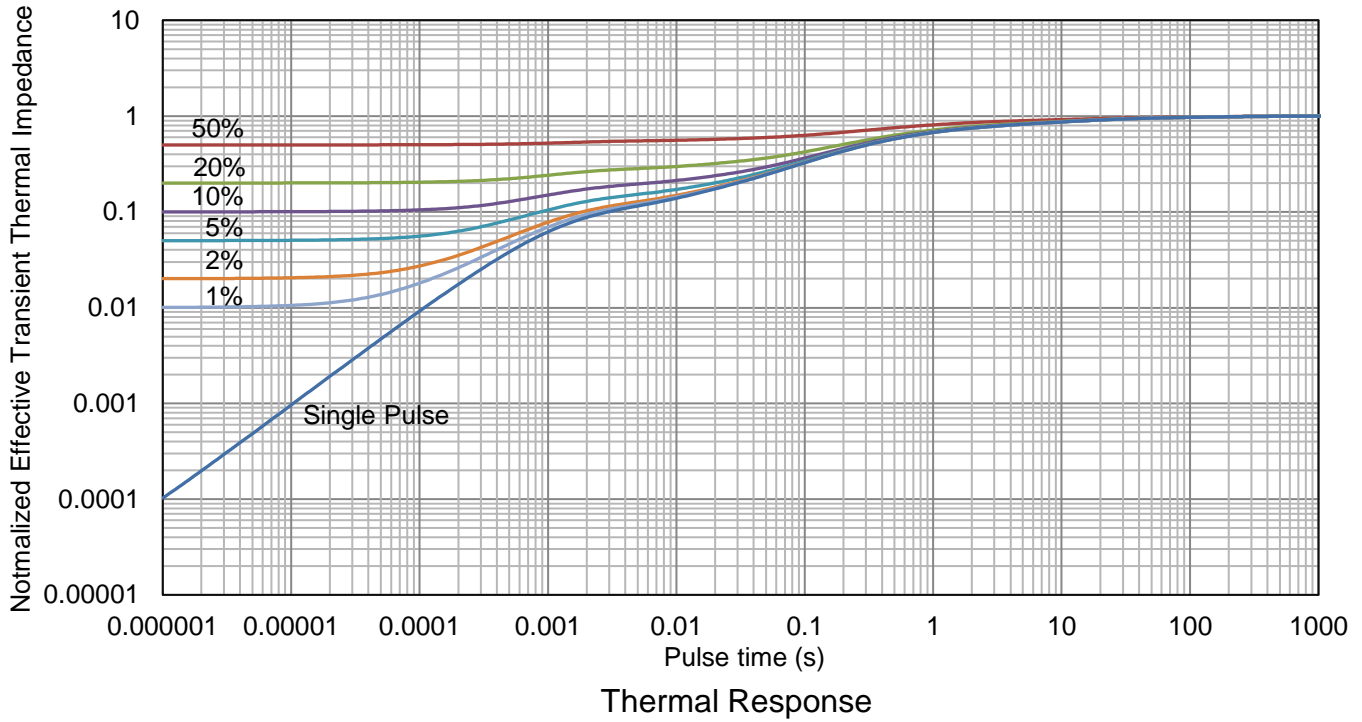

8.OUTLINE AND DIMENSIONS

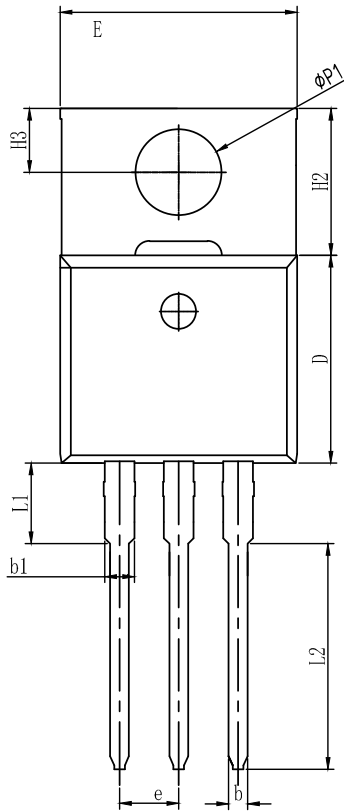

TOP VIEW

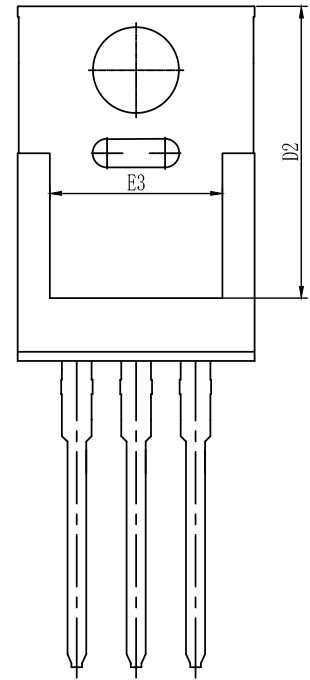
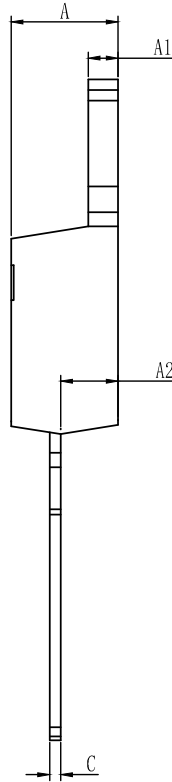

BOTTOM VIEW

GENERAL NOTES

1. Top package surface finish Ra Max1.2±0.2um
2. Bottom package surface finish Ra Max0.2um
3. Protrusion or Gate Burrs shall not exceed 0.05mm per side.
4. Off center Max0.05mm; Mismatch Max 0.05mm.

DIM	MILLIMETERS		
	MIN	NOM	MAX
A	4.42	4.57	4.72
A1	1.20	1.30	1.40
A2	2.35	2.45	2.55
b	0.73	0.83	0.93
b1	1.20	1.30	1.40
c	0.41	0.48	0.58
D	8.70	8.90	9.10
D2	12.20	12.50	12.80
E	9.85	10.15	10.45
E3	7.10	7.40	7.70
e	2.54BSC		
H2	6.10	6.30	6.50
H3	2.54	2.74	2.94
L1	3.16	3.46	3.76
L2	9.36	9.66	9.96
ØP1	3.48	3.68	3.88

DISCLAIMER

- Curve guarantee in the specification. The curve of test items with electric parameter is used as quality guarantee. The curve of test items without electric parameter is used as reference only.
- Before you use our Products for new Porject, you are requested to carefully read this document and fully understand its contents. LRC shall not be in any way responsible or liable for failure, malfunction or accident arising from the use of any LRC's Products against warning, caution or note contained in this document.
- All information contained in this document is current as of the issuing date and subject to change without any prior notice. Before purchasing or using LRC's Products, please confirm the latest information with a LRC sales representative.