

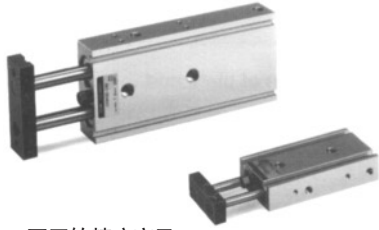

双联气缸/基本型 CXS系列(ø6~ø32)



薄型双气缸结构，不回转精度高及
2倍输出力，抵抗侧面负载力强。

型号表示方法

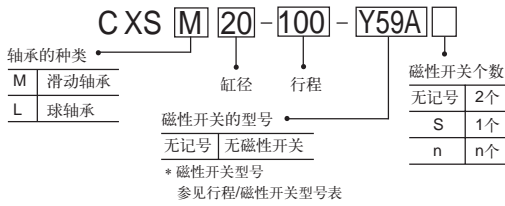

缸体可以4个方向用螺钉固定，供气口位置可选择

顶部固定

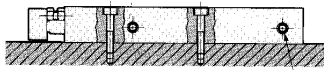

底部固定

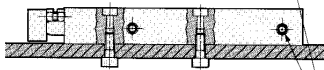

侧面固定

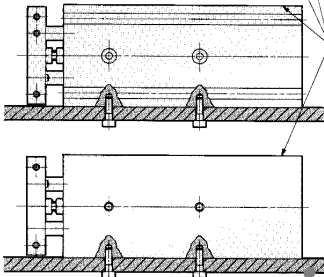

供气口
(对面的气口是相同的)

行程/磁性开关型号表

缸径 (mm)	标准行程 (mm)	* 磁性开关型号 (轨道安装)
6	10, 20, 30, 40, 50	Z73, Z76, Z77, Z78, Z79, Z80, Z81, Z82, Z83, Z84, Z85, Z86, Z87, Z88, Z89, Z90, Z91, Z92, Z93, Z94, Z95, Z96, Z97, Z98, Z99, Y59A, Y59B
10	10, 15, 20, 25, 30, 35, 40, 45, 50, 60, 70, 75	
15	10, 15, 20, 25, 30, 35, 40, 45, 50, 60, 70, 75, 80, 90, 100	
20	10, 15, 20, 25, 30, 35, 40, 45, 50, 60, 70, 75, 80, 90, 100	
25	10, 15, 20, 25, 30, 35, 40, 45, 50, 60, 70, 75, 80, 90, 100	
32	10, 15, 20, 25, 30, 35, 40, 45, 50, 60, 70, 75, 80, 90, 100	

磁性开关规格及特性可参阅磁性开关系列。
导轨安装表示记号: 无记号-0.5m, L-3m, Z-5m

可在端板上3个平面安装工件

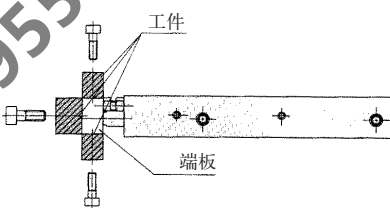

外形尺寸图 (毫米)

CXS □6

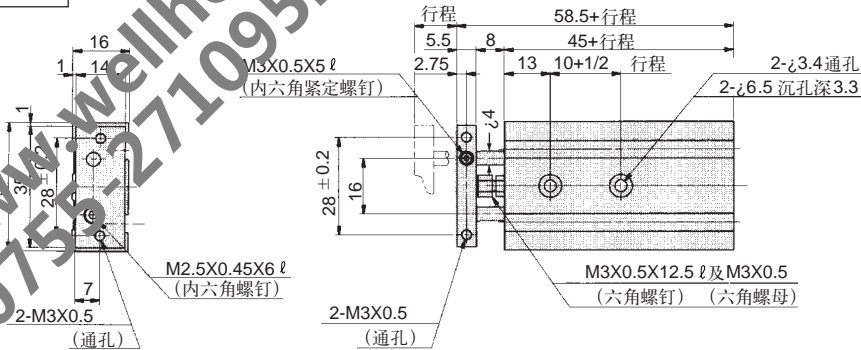

型号	行程	10+1/2行程	13+行程	45+行程	58.5+行程
CXS □6-10	10	15	23	55	68.5
CXS □6-20	20	20	33	65	78.5
CXS □6-30	30	25	43	75	88.5
CXS □6-40	40	30	53	85	98.5
CXS □6-50	50	35	63	95	108.5

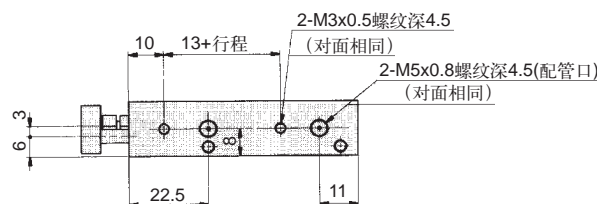

标准规格

缸径(mm)	6	10	15	20	25	32
流体	空气					
动作方式	双作用					
最高使用压力MPa	0.7					
最低使用压力MPa	0.15	0.1	0.05			
环境和流体温度	-10~60℃ (但未冻结)					
缓冲	两端橡胶缓冲					
使用活塞速度mm/s	30~300	30~800	30~700	30~600		
结构	双气缸(2倍输出力)					
*给油	不需要					
行程调整范围	缩回行程 0~5mm					
轴承	滑动轴承/球轴承					
活塞杆不回转	滑动轴承 0.1°					
精度	球轴承 ±0.1°					
接管口径Rc	M/R0.8				1/8	

* 如需润滑, 请用透平1号油|SOVG32。适合缸径: 6 (N)

型号	行程(mm)				
	0	20	30	40	50
CXS □6	0.80	0.66	0.54	0.46	0.40
CXSL □6	1.08	0.88	0.69	0.59	0.49

适合缸径: ø10~ø32mm

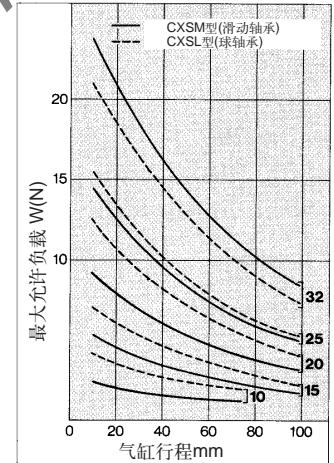

最大允许负载

下图所示的安装形式，气缸所受最大允许负载是低于上图所列。

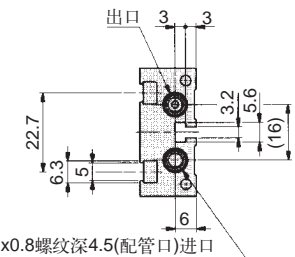
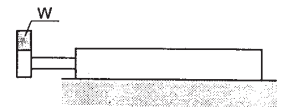

双联气缸：CXS系列

外形尺寸图（毫米）

CXS□10 · 15 · 20 · 25 · 32

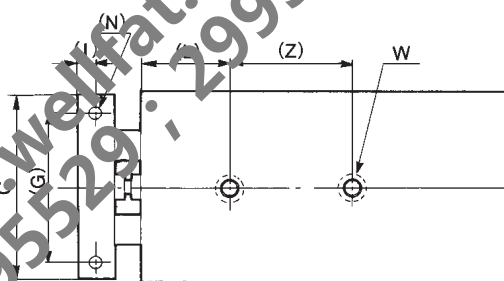
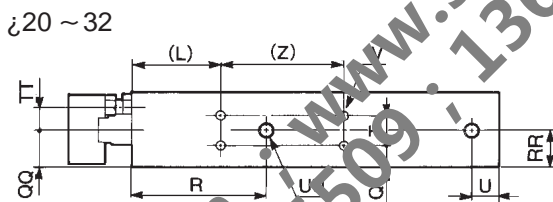
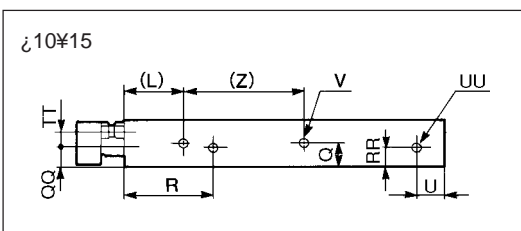
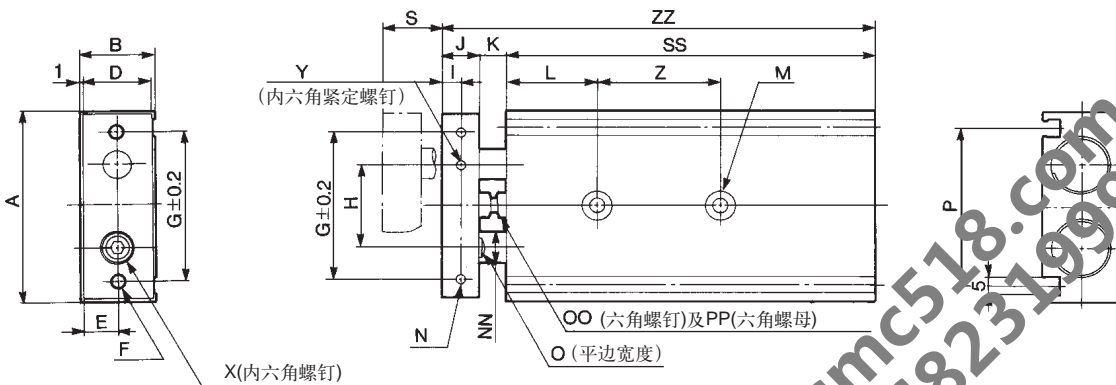

型号	A	B	C	D	E	F	H	I	J	K	M	N	NN	O	OO	P	PP	Q	QQ	R	RR	S	SS	T	TT	U	UU	V	W	X	Y	Z	ZZ
CXS○10-10																						10	65				4-M5 X0.8	4-M3 X0.5	2-M4 X0.7	M3 x 0.5	M3 x 0.5	30	82
CXS○10-20																						20	75				4-M5 X0.8	4-M3 X0.5	2-M4 X0.7	M3 x 0.5	M3 x 0.5		92
CXS○10-30	46	17	44	15	7.5	2-M4 X0.7 (通孔)	35	10	8	9	20	2-φ6.5 沉孔深度 3.3	2-M3 X0.5 螺孔深度 5	φ6	5	33.6	M4 X 0.7	8.5	7	30	7	30	85		5	8	(接气口) (对面相同)	(对面相同)	M3 x 0.5	M3 x 0.5	40	102	
CXS○10-40																						40	95				(接气口) (对面相同)	(对面相同)	M3 x 0.5	M3 x 0.5	40	112	
CXS○10-50																						50	105				(接气口) (对面相同)	(对面相同)	M3 x 0.5	M3 x 0.5	40	122	
CXS○15-10																						10	70				4-M5 X0.8	4-M4 X0.7	2-M5 X0.8	M5 x 0.8	M4 x 0.7	25	89
CXS○15-20																						20	80				4-M5 X0.8	4-M4 X0.7	2-M5 X0.8	M5 x 0.8	M4 x 0.7		99
CXS○15-30	58	20	78	18	11.5	2-M5 X0.8 (通孔)	45	25	5	10	9	30	2-φ4.3 通孔 2-φ9 沉孔深度 4.4	2-M4 X0.7 螺孔深度 6	φ8	6	48	M4 X 0.7	10	10	38.5	10	30	90		5	8	(接气口) (对面相同)	(对面相同)	M5 x 0.8	M4 x 0.7	35	109
CXS○15-40																						40	100				(接气口) (对面相同)	(对面相同)	M5 x 0.8	M4 x 0.7	35	119	
CXS○15-50																						50	110				(接气口) (对面相同)	(对面相同)	M5 x 0.8	M4 x 0.7	35	129	
CXS○20-10																						10	80				4-M5 X0.8	4-M4 X0.7	2-M6 X1.0	M6 x 1.0	M5 x 0.8	30	104
CXS○20-20																						20	90				4-M5 X0.8	4-M4 X0.7	2-M6 X1.0	M6 x 1.0	M5 x 0.8		114
CXS○20-30	64	25	78	23	11.5	2-M5 X0.8 (通孔)	50	28	6	12	12	30	2-φ5.5 通孔 2-φ9.5 沉孔深度 5.3	2-M4 X0.7 螺孔深度 6	φ10	8	53	M6 X 1.0	7.75	12.5	45	7.75	40	110	9.5	6.5	8	(接气口) (对面相同)	(对面相同)	M6 x 1.0	M5 x 0.8	40	124
CXS○20-40																						50	120				(接气口) (对面相同)	(对面相同)	M6 x 1.0	M5 x 0.8	40	144	
CXS○20-50																						75	145				(接气口) (对面相同)	(对面相同)	M6 x 1.0	M5 x 0.8	60	169	
CXS○25-10																						100	170				4-M5 X0.8	4-M4 X0.7	2-M6 X1.0	M6 x 1.0	M5 x 0.8	60	194
CXS○25-20																						10	82				4-M5 X0.8	4-M4 X0.7	2-M6 X1.0	M6 x 1.0	M5 x 0.8	30	106
CXS○25-30																						20	92				4-M5 X0.8	4-M4 X0.7	2-M6 X1.0	M6 x 1.0	M5 x 0.8		116
CXS○25-40	80	30	78	28	14	2-M6 X1.0 (通孔)	60	35	6	12	12	30	2-φ6.9 通孔 2-φ11 沉孔深度 6.3	2-M5 X0.8 螺孔深度 7.5	φ12	10	64	M6 X 1.0	8.5	15	46	15	40	112	13	9	9	(接气口) (对面相同)	(对面相同)	M6 x 1.0	M6 x 1.0	40	136
CXS○25-50																						50	122				(接气口) (对面相同)	(对面相同)	M6 x 1.0	M6 x 1.0	40	146	
CXS○25-75																						75	147				(接气口) (对面相同)	(对面相同)	M6 x 1.0	M6 x 1.0	60	171	
CXS○25-100																						100	172				(接气口) (对面相同)	(对面相同)	M6 x 1.0	M6 x 1.0	60	196	
CXS○32-10																						10	92				4-M5 X0.8	4-M4 X0.7	2-M8 X1.25	M8 x 1.25	M8 x 1.25	40	122
CXS○32-20																						20	102				4-M5 X0.8	4-M4 X0.7	2-M8 X1.25	M8 x 1.25	M8 x 1.25		132
CXS○32-30																						30	112				4-M5 X0.8	4-M4 X0.7	2-M8 X1.25	M8 x 1.25	M8 x 1.25		142
CXS○32-40	98	38	96	36	18	2-M6 X1.0 (通孔)	75	44	8	16	14	30	2-φ6.9 通孔 2-φ11 沉孔深度 6.3	2-M5 X0.8 螺孔深度 8	φ16	13	76	M8 X 1.25	9	19	56	19	40	122	20	11.5	10	(接气口) (对面相同)	(对面相同)	M8 x 1.25	M8 x 1.25	50	152
CXS○32-50																						50	132				(接气口) (对面相同)	(对面相同)	M8 x 1.25	M8 x 1.25	70	162	
CXS○32-75																						75	157				(接气口) (对面相同)	(对面相同)	M8 x 1.25	M8 x 1.25	70	187	
CXS○32-100																						100	182				(接气口) (对面相同)	(对面相同)	M8 x 1.25	M8 x 1.25	70	212	